

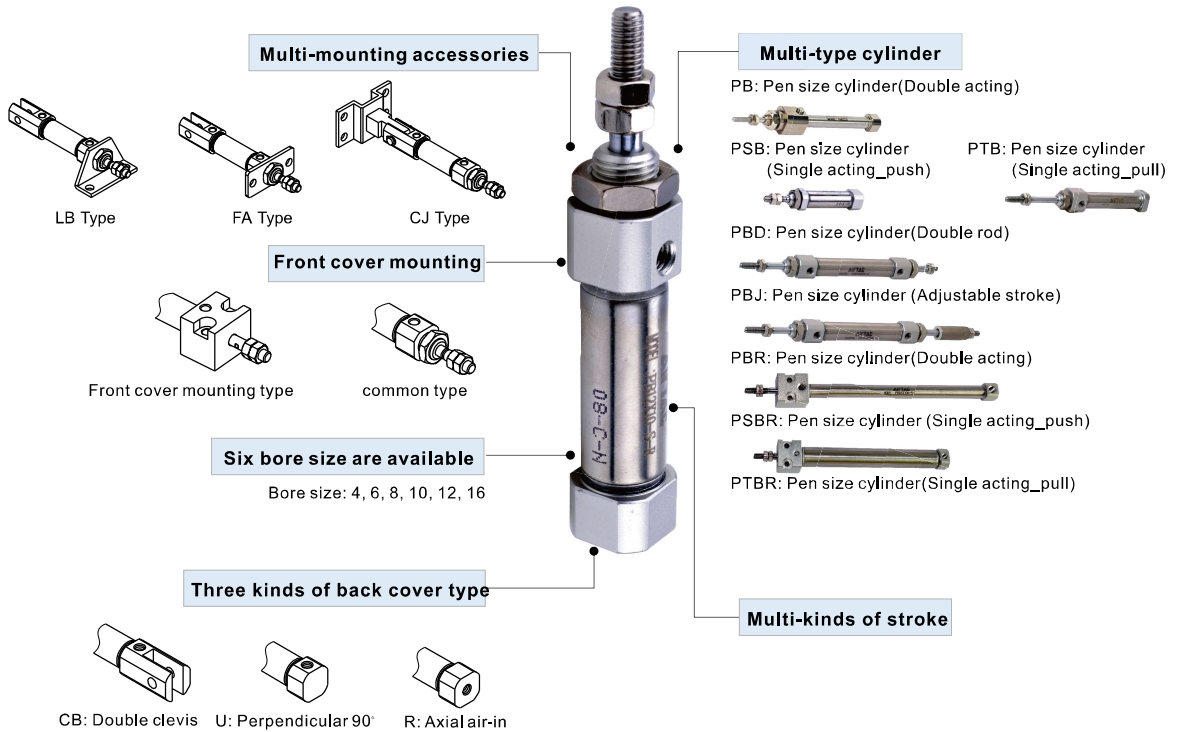

# Pen size cylinder—PB Series

## Compendium of PB Series



### Criteria for selection: Cylinder thrust

Unit: Newton(N)

Bore size	Rod size	Acting type	Pressure area(mm <sup>2</sup> )	Operating pressure(MPa)						
				0.1	0.2	0.3	0.4	0.5	0.6	0.7
4	2	Single acting_Push side	12.6	-	-	1.6	2.8	4.1	5.3	6.6
		Double acting Pull side	9.4	0.9	1.9	2.8	3.8	4.7	5.6	6.6
6	3	Single acting_Push side	28.3	-	-	5.0	7.8	10.6	13.5	16.3
		Double acting Pull side	21.2	-	-	2.9	5.0	7.1	9.2	11.3
8	4	Single acting_Push side	50.3	-	-	8.6	13.6	18.7	23.7	28.7
		Double acting Pull side	37.7	-	-	4.8	8.6	12.4	16.1	19.9
10	4	Single acting_Push side	78.5	-	-	14.1	21.9	29.8	37.6	45.5
		Double acting Pull side	65.9	-	-	7.9	15.7	23.6	31.4	39.3
12	5	Single acting_Push side	113.0	-	-	20.3	31.6	42.9	54.2	65.5
		Double acting Pull side	93.4	-	-	11.3	22.6	33.9	45.2	56.5
16	5	Single acting_Push side	201.0	-	-	34.6	54.7	74.8	94.9	115.0
		Double acting Pull side	181.3	-	-	10.6	28.7	46.8	65.0	83.1
		Double acting Pull side	181.3	18.1	36.3	54.4	72.5	90.7	108.8	126.9

### Installation and application



- When load changes in the work, the cylinder with abundant output capacity shall be selected.
- Relative cylinder with high temperature resistance or corrosion resistance shall be chosen under the condition of high temperature or corrosion.
- Necessary protection measure shall be taken in the environment with higher humidity, much dust or water drops, oil dust and welding dregs.
- Dirty substances in the pipe must be eliminated before cylinder is connected with pipeline to prevent the entrance of particles into the cylinder.
- The medium used by cylinder shall be filtered to 40μm or below.
- Anti-freezing measure shall be adopted under low temperature environment to prevent moisture freezing.
- The load of the cylinder with the diameter of Φ4 needs to be coaxial with the cylinder to avoid side load, otherwise, piston rod will be bent and deformed and damage the thread at the end of the rod. Single-acting type can not be added in return.
- If the cylinder is dismantled and stored for a long time, Please to conduct anti-rust treatment to the surface. Anti-dust caps shall be added in air inlet and outlet ports. The front and back cover can not be dismantled, which shall be especially noticed.



# Pen size cylinder

## PB Series



### Specification

Bore size (mm)	4		6		10		12		16		
Acting type	Double acting, Single acting_Push				Double acting, Single acting						
Fluid	Air (to be filtered by 40μm filter element)										
Operating pressure	Double acting	0.2~0.7MPa(28~100psi)(2.0~7.0bar)				0.15~0.7MPa(22~100psi)(1.5~7.0bar)					
	Single acting	0.3~0.7MPa(45~100psi)(3.0~7.0bar)				0.2~0.7MPa(28~100psi)(2.0~7.0bar)					
Proof pressure	1.2MPa(175psi)(12bar)										
Temperature °C	-20~70										
Speed range mm/s	50~500				50~800						
Stroke tolerance	+0.5 0				0~150 <sup>+1.0</sup> <sub>0</sub> >150 <sup>+1.5</sup> <sub>0</sub>						
Cushion type	No cushion				Bumper						
Port size	Tube				M5×0.8						

(Add) Refer to P590 for detail of sensor switch.

### Symbol

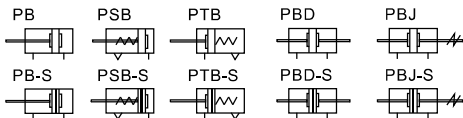

### Stroke

Bore size (mm)	Standard stroke (mm)	Max.std stroke	Max. stroke	
PB	4	5 10 15 20	20	20
	6	10 15 20 25 30 40 50 60	60	60
	10	10 15 20 25 30 40 50 60 75 80 100 125 150 160 175 200	200	200
	12	10 15 20 25 30 40 50 60 75 80 100 125 150 160 175 200	200	300
	16	10 15 20 25 30 40 50 60 75 80 100 125 150 160 175 200 250 300	300	300
PBD	6	5 10 15 20 25 30 40 50	50	-
	10	10 15 20 25 30 40 50 60 75 80 100	100	-
PBD	12	10 15 20 25 30 40 50 60 75 80 100 125 150 160 175 200	200	-
	16	10 15 20 25 30 40 50 60 75 80 100 125 150 160 175 200	200	-
PSB	4	5 10 15 20	-	-
	6	5 10 15 20 25 30 40 50 60	-	-
PSB	10	5 10 15 20 25 30 40 50 60	-	-
	12	5 10 15 20 25 30 40 50 60	-	-
PTB	12	5 10 15 20 25 30 40 50 60	-	-
	16	5 10 15 20 25 30 40 50 60	-	-

[Note] Consult us for non-standard stroke.

### Product feature

- JIS standard is implemented.
- It belongs to mini cylinder that has compact structure, small volume and light weight.
- The guide precision of piston rod is high and no additional lubricant is needed.
- PB4 and PB6 can only be front mounted. PB10, PB12 and PB16 has the flexibility of both front and rear mount.
- Piston rod and cylinder body with the material of stainless steel make the cylinder adapt general working environment with corrosivity.
- There are cylinders and accessories with several specifications for installation for your choice.
- It has small cylinder diameter and quick reaction, suitable for the working environment with higher frequency.

### Ordering code

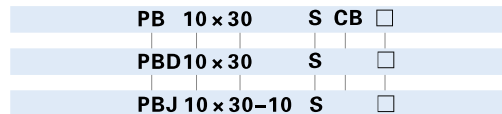

① Model	② Bore size	③ Stroke	④ Adjustable stroke	⑤ Magnet	⑥ Back cover		⑦ Mounting type [Note 1]							
PB: Pen size cylinder (Double acting)	4	Refer to stroke table for details	No this code	Blank: Without magnet S: With magnet	Model	Back cover	Bore size	Model	Mounting type					
PSB: Pen size cylinder (Single acting_push)	6									CB: Double clevis	Φ10~Φ16	PB PSB PTB	Blank: No accessories FA: FA type LB: LB type CJ: CJ type	
	10									U: Perpendicular 90°	Φ10~Φ16			
	12									R: Axial air-in	Φ6~Φ16			
	16									CB: Double clevis	Φ10~Φ16			
PTB: Pen size cylinder (Single acting_pull)	6										Φ6~Φ16			
PBD: Pen size cylinder (Double rod)	10											PBD PBJ		Blank: No accessories FA: FA type LB: LB type
	12													
	16													
PBJ: Pen size cylinder (Adjustable stroke)	10										10 20 30			
	12		40 50 75 100											
	16													

[Note 1] Please refer to page 324 for accessory parts.

# Pen size cylinder

## PB Series

### Inner structure and material of major parts

#### Double acting without magnet

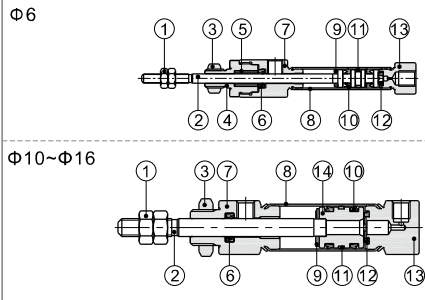

NO.	Item	Material
1	Rod nut	Carbon steel
2	Piston rod	SUS304
3	Front cover nut	Carbon steel
4	Packing retainer	Brass(Φ4)\Aluminum alloy(Others)
5	Bushing	Wear resistant material
6	Front cover O-ring	NBR
7	Front cover	Brass(Φ4)\Aluminum alloy(Others)
8	Barrel	Bronze(Φ4)\SUS304(Others)
9	Bumper	TPU
10	Piston seal	NBR
11	Wear ring	Wear resistant material
12	Bumper	TPU
13	Back cover	Brass(Φ4)\Aluminum alloy(Others)
14	Piston	Aluminum alloy(Φ16)\Stainless steel(Others)

Note: inner structure & material data sheet is based on certain bore size.  
Please contact AirTAC if you need inner structure & material data sheet for specific bore size.

### Dimensions

#### PB

##### Φ4(Without magnet)(R Type)

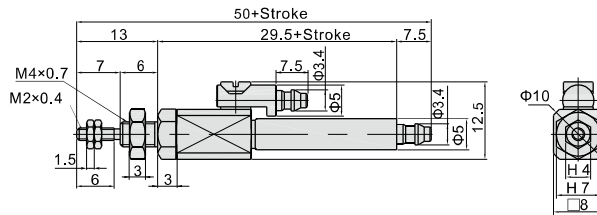

##### Φ6(R Type)

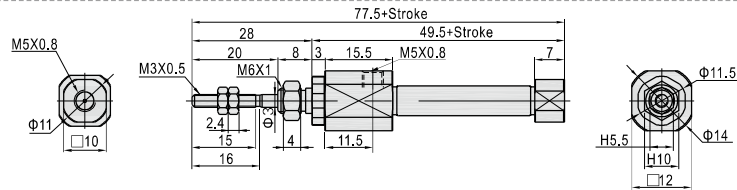

Note) Only axial air intake type of back cover is available for Φ4, Φ6mm bore size.

#### Φ10-Φ16

##### U Type(Perpendicular 90°)

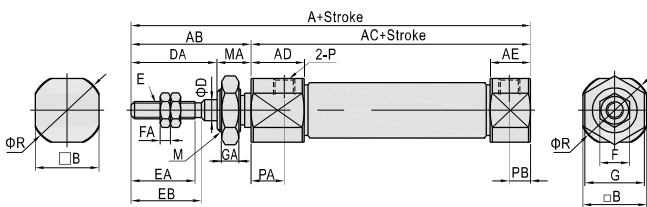

##### CB Type(Double clevis)

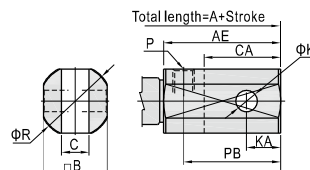

##### R Type(Axial air-in)

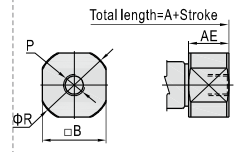

Bore size\Item	A		AB	AC	AD	AE		B	C	CA	D	DA	E	EA	EB	F	FA	G	GA	K	KA	M	MA	P	PA	PB			
	U	CB				R	U																			CB	R		
10	74	87	74	28	46	11.5	9.5	22.5	12	3.3	13	4	20	M4×0.7	15	16.5	7	3	11	4	3.3	5	M8×1.0	8	M5×0.8	7.5	5	18	14
12	74	92	74	28	46	11.5	9.5	27.5	15	6.6	18	5	20	M5×0.8	15	16.5	8	4	14	4	5	8	M10×1.0	8	M5×0.8	7.5	5	23	17
16	76	94	76	28	48	12	9.5	27.5	18	6.6	18	5	20	M5×0.8	15	16.5	8	4	14	4	5	8	M10×1.0	8	M5×0.8	7.5	5	23	20

Remark: The dimensions of magnet type cylinder are the same as non-magnet type cylinder.

# Pen size cylinder

## PB Series

### PSB Φ4(Without magnet)(R Type)

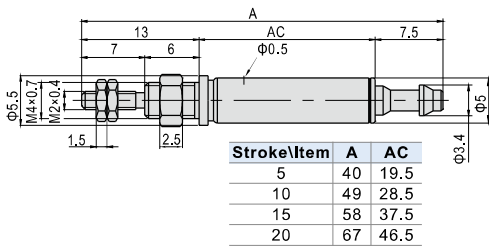

### Φ6(R Type)

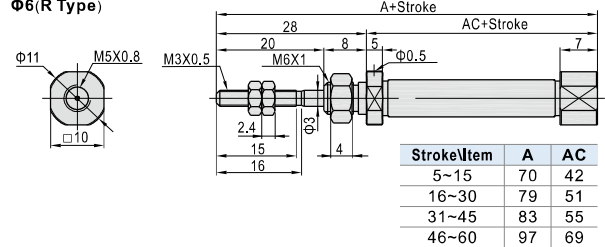

Note) Only axial air intake type of back cover is available for Φ4, Φ6mm bore size.

### Φ10~Φ16

#### U Type(Perpendicular 90°)

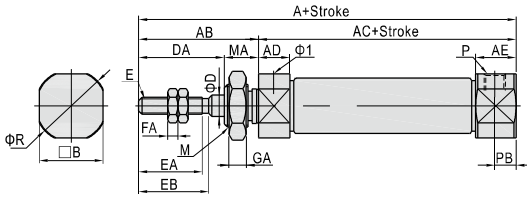

#### CB Type(Double clevis)

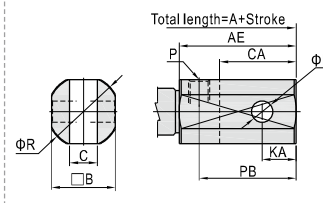

#### R Type(Axial air-in)

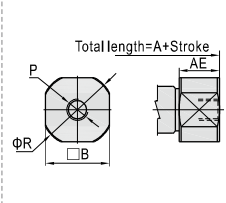

Bore size\Item	A												AB	AC				AD	AE		B	C
	U				CB				R					-	-							
Stroke	5~15	16~30	31~45	46~60	5~15	16~30	31~45	46~60	5~15	16~30	31~45	46~60	5~15	16~30	31~45	46~60	5	9.5	22.5	12	3.3	
10	73.5	81	93	105	86.5	94	106	118	73.5	81	93	105	28	45.5	53	65	77	5	9.5	22.5	15	6.6
12	73.5	81	93	105	91.5	99	111	123	73.5	81	93	105	28	45.5	53	65	77	5	9.5	27.5	15	6.6
16	74.5	83	95	107	92.5	101	113	125	74.5	83	95	107	28	46.5	55	67	79	5	9.5	27.5	18	6.6

Bore size\Item	CA	D	DA	E	EA	EB	F	FA	G	GA	K	KA	M	MA	P	PB			R
																U	CB	R	
10	13	4	20	M4×0.7	15	16.5	7	3	11	4	3.3	5	M8×1.0	8	M5×0.8	5	18	14	
12	18	5	20	M5×0.8	15	16.5	8	4	14	4	5	8	M10×1.0	8	M5×0.8	5	23	17	
16	18	5	20	M5×0.8	15	16.5	8	4	14	4	5	8	M10×1.0	8	M5×0.8	5	23	20	

Remark: The dimensions of magnet type cylinder are the same as non-magnet type cylinder.

### PTB Φ6(R Type)

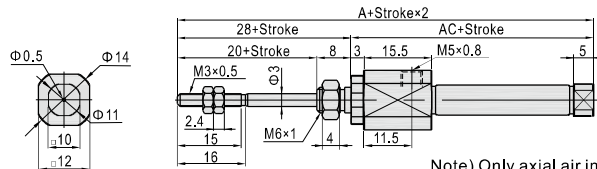

Stroke\Item	A	AC
5~15	82	54
16~30	91	63
31~45	95	67
46~60	109	81

Note) Only axial air intake type of back cover is available for Φ6mm bore size.

### Φ10~Φ16

#### R Type(Axial air-in)

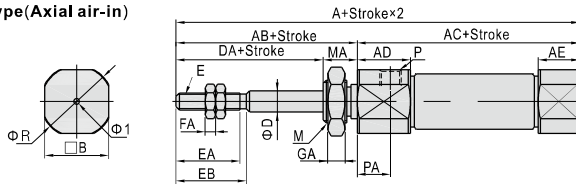

#### CB Type(Double clevis)

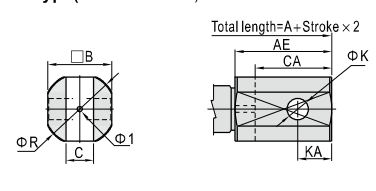

Bore size\Item	A												AB	AC				AD
	R				CB				-									
Stroke	5~15	16~30	31~45	46~60	5~15	16~30	31~45	46~60	5~15	16~30	31~45	46~60	5~15	16~30	31~45	46~60	5	
10	76.5	84	96	108	89.5	97	109	121	28	48.5	56	68	80	11.5				
12	76.5	84	96	108	94.5	102	114	126	28	48.5	56	68	80	11.5				
16	77.5	86	98	110	95.5	104	116	128	28	49.5	58	70	82	12				

Bore size\Item	AE	R	CB	B	C	CA	D	DA	E	EA	EB	F	FA	G	GA	K	KA	M	MA	P	PA	R
12	5	23	15	6.6	18	5	20	M5×0.8	15	16.5	8	4	14	4	5	8	M10×1.0	8	M5×0.8	7.5	17	
16	5	23	18	6.6	18	5	20	M5×0.8	15	16.5	8	4	14	4	5	8	M10×1.0	8	M5×0.8	7.5	20	

Note) Φ10~Φ16 bore sizes don't have perpendicular(90°) air-in.

Remark: The dimensions of magnet type cylinder are the same as non-magnet type cylinder.



# Pen size cylinder

## PB Series

### PBD

Φ6

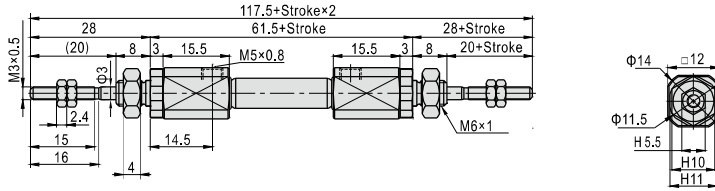

### Φ10-Φ16

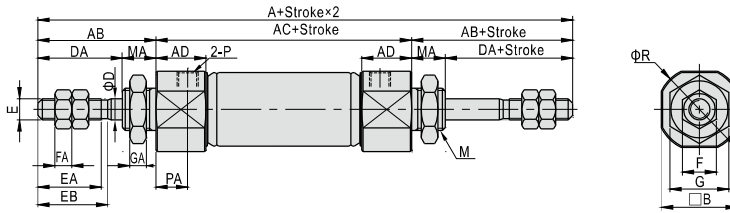

### PBJ

Φ10-Φ16

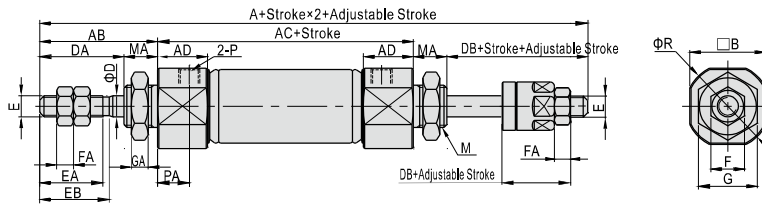

Bore size/Item Model	A		AB	AC	AD	B	D	DA	DB	E	EA	EB	F	FA	G	GA	M	MA	P	PA
	PBD	PBJ																		
10	104	99	28	48	11.5	12	4	20	15	M4×0.7	15	16.5	7	3	11	4	M8×1.0	8	M5×0.8	7.5
12	104	101	28	48	11.5	15	5	20	17	M5×0.8	15	16.5	8	4	14	4	M10×1.0	8	M5×0.8	7.5
16	107	104	28	51	12	18	5	20	17	M5×0.8	15	16.5	8	4	14	4	M10×1.0	8	M5×0.8	7.5

Remark: The dimensions of magnet type cylinder are the same as non-magnet type cylinder.

# Pen size cylinder

## PBR Series



### Specification

Bore size(mm)	6	8	10	12	16
Acting type	Double acting, Single acting				
Fluid	Air(to be filtered by 40µm filter element)				
Operating pressure	Double acting	0.15~0.7MPa(22~100psi)(1.5~7.0bar)			
	Single acting	0.3~0.7MPa(45~100psi)(3.0~7.0bar)   0.2~0.7MPa(28~100psi)(2.0~7.0bar)			
Proof pressure	1.2MPa(175psi)(12bar)				
Temperature °C	-20~70				
Speed range mm/s	50~800				
Stroke tolerance	0~150 $^{+1.0}_0$ >150 $^{+1.5}_0$				
Cushion type	Bumper				
Port size	M5×0.8				

Add) Refer to P590 for detail of sensor switch.

### Stroke

Bore size (mm)	Standard stroke (mm)	Max.std stroke	Max. stroke	
PBR	6	10 15 20 25 30 40 50 60	60	60
	8	10 15 20 25 30 40 50 60 75 80 100 125 150	150	200
	10	10 15 20 25 30 40 50 60 75 80 100 125 150 160 175 200	200	200
	12	10 15 20 25 30 40 50 60 75 80 100 125 150 160 175 200	200	300
	16	10 15 20 25 30 40 50 60 75 80 100 125 150 160 175 200 250 300	300	300
PSBR PTBR	6	5 10 15 20 25 30 40 50 60	-	-
	8	5 10 15 20 25 30 40 50 60	-	-
	10	5 10 15 20 25 30 40 50 60	-	-
	12	5 10 15 20 25 30 40 50 60 75	-	-
16	5 10 15 20 25 30 40 50 60 75 100	-	-	

[Note] Consult us for non-standard stroke.

### Symbol

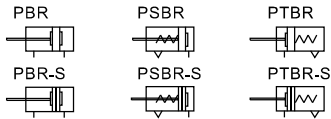

### Product feature

- JIS standard is implemented.
- It belongs to mini cylinder that has compact structure, small volume and light weight.
- The guide precision of piston rod is high and no additional lubricant is needed.
- Screw holes are designed for mounting directly at the front cover without any accessories.
- Piston rod stainless steel barrel make the cylinder adapt general corrosive working environment.
- It has small cylinder diameter and quick reaction, suitable for the working environment with higher frequency.

### Ordering code

#### PBR 16 x 30 S U



① Model	② Bore size	③ Stroke	④ Magnet	⑤ Back cover		
				Model	Back cover	Bore size
PBR: Pen size cylinder(Double acting) PSBR: Pen size cylinder (Single acting_push) PTBR: Pen size cylinder(Single acting_pull)	6	Refer to stroke table for details	Blank: Without magnet S: With magnet	PBR	U: Perpendicular 90°	Φ8~Φ16
	8			PSBR	R: Axial air-in	Φ6~Φ16
	10			PTBR	R: Axial air-in	Φ6~Φ16
	12					
	16					

### Mounting type

#### Top bolt mounting

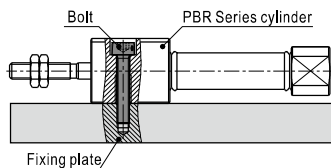

#### Bottom bolt mounting

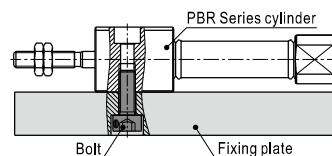

Note: Select appropriate bolt based on actual working conditions when mounting from the bottom.

## PBR Series

### Inner structure and material of major parts

#### Double acting with magnet

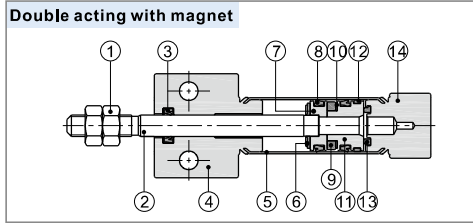

NO.	Item	Material	NO.	Item	Material
1	Rod nut	Carbon steel	8	Piston seal	NBR
2	Piston rod	SUS304	9	Magnet	Sintered metal(Neodymium-iron-boron)
3	Front cover O-ring	NBR	10	Magnet washer	NBR
4	Front cover	Aluminum alloy	11	Magnet holder	SUS303\Aluminum alloy
5	Barrel	SUS316L	12	Wear ring	Wear resistant material
6	Bumper	TPU	13	Bumper	TPU
7	Piston	SUS303\Aluminum alloy	14	Back cover	Aluminum alloy

Note: inner structure & material data sheet is based on certain bore size.  
Please contact AirTAC if you need inner structure & material data sheet for specific bore size.

### Dimensions

#### PBR

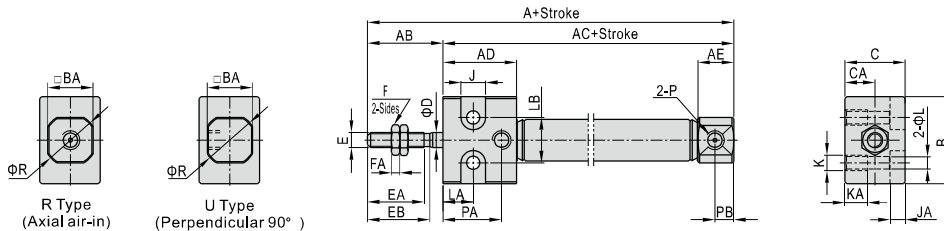

Bore size\Item	A	AB	AC	AD	AE	B	BA	C	CA	D	E	EA	EB	F	FA	J	JA	K	KA	L	LA	LB	P	PA	PB	R
6	70	20	50	19	7	17	10	14	7	3	M3×0.5	15	16	5.5	2.4	6.5	4	M4×0.7	7	3.3	8	10	M5×0.8	14	-	11
8	74	20	54	19.5	9.5	19	12	16	8	4	M4×0.7	15	16.5	7	3	6.5	4	M4×0.7	7	3.3	8	12	M5×0.8	15	5	14
10	74	20	54	19.5	9.5	19	12	16	8	4	M4×0.7	15	16.5	7	3	6.5	4	M4×0.7	7	3.3	8	12	M5×0.8	15.5	5	14
12	74	20	54	19.5	9.5	24	15	20	10	5	M5×0.8	15	16.5	8	4	8	5	M5×0.8	8	4.3	8	16	M5×0.8	15.5	5	17
16	76	20	56	20	9.5	24	18	20	10	6	M5×0.8	15	16.5	8	4	8	5	M5×0.8	8	4.3	8	16	M5×0.8	15.5	5	20

Remark: The dimensions of magnet type cylinder are the same as non-magnet type cylinder. Only axial air intake type of back cover is available for Φ6mm bore size.

#### PSBR

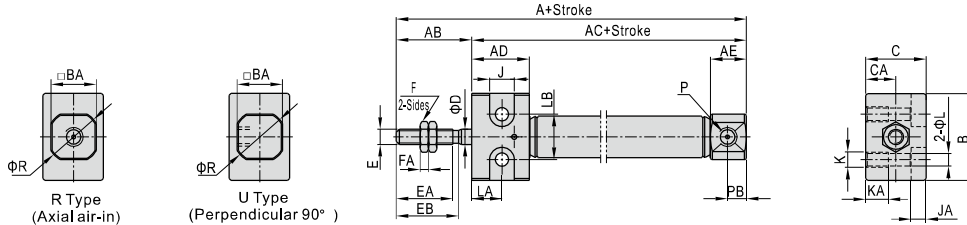

#### PTBR

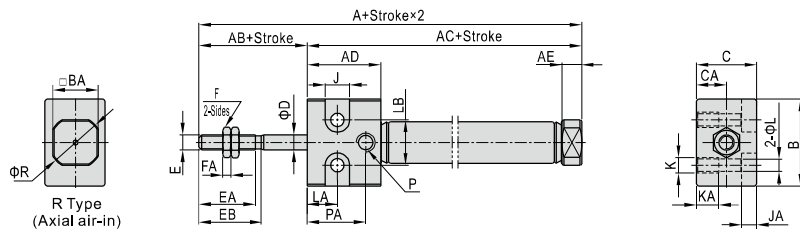

Bore size\Item	Model	A										AC													
		PSBR					PTBR					PSBR					PTBR								
Stroke		5-15	16-30	31-45	46-60	61-75	76-100	5-15	16-30	31-45	46-60	61-75	76-100	5-15	16-30	31-45	46-60	61-75	76-100	5-15	16-30	31-45	46-60	61-75	76-100
6		70	79	83	97	-	-	74.5	83.5	87.5	101.5	-	-	50	59	63	77	-	-	54.5	63.5	67.5	81.5	-	-
8		76.5	82.5	93.5	101.5	-	-	78.5	84.5	95.5	103.5	-	-	56.5	62.5	73.5	81.5	-	-	58.5	64.5	75.5	83.5	-	-
10		73.5	81	93	105	-	-	76.5	84	96	108	-	-	53.5	61	73	85	-	-	56.5	64	76	88	-	-
12		73.5	81	93	105	111.5	-	76.5	84	96	108	114.5	-	53.5	61	73	85	91.5	-	56.5	64	76	88	94.5	-
16		74.5	83	95	107	113	119	77.5	86	98	110	116	122	54.5	63	75	87	93	99	57.5	66	78	90	96	102

Bore size\Item	AD		AE		B	BA	C	CA	D	E	EA	EB	F	FA	J	JA	K	KA	L	LA	LB	P	PA	PB	R		
	Model	PSBR	PTBR	PSBR																						PTBR	
6		13	19	20	7	5	17	10	14	7	3	M3×0.5	15	16	5.5	2.4	6.5	4	M4×0.7	7	3.3	8	10	M5×0.8	14	-	11
8		13	19.5	20	9.5	5	19	12	16	8	4	M4×0.7	15	16.5	7	3	6.5	4	M4×0.7	7	3.3	8	12	M5×0.8	15	5	14
10		13	19.5	20	9.5	5	19	12	16	8	4	M4×0.7	15	16.5	7	3	6.5	4	M4×0.7	7	3.3	8	12	M5×0.8	15.5	5	14
12		13	19.5	20	9.5	5	24	15	20	10	5	M5×0.8	15	16.5	8	4	8	5	M5×0.8	8	4.3	8	16	M5×0.8	15.5	5	17
16		13	20	20	9.5	5	24	18	20	10	6	M5×0.8	15	16.5	8	4	8	5	M5×0.8	8	4.3	8	16	M5×0.8	15.5	5	20

Remark: The dimensions of magnet type cylinder are the same as non-magnet type cylinder. Only axial air intake type of back cover is available for Φ6mm bore size.

# Pen size cylinder

## PB Series—Accessories

### List for ordering code of accessories

Accessories Bore size	Mounting accessories			Knuckle				Sensor switch		
	LB	FA	CJ	I	Y	F	U	CMSG	DMSG	EMSG
4	-	-	-	-	-	-	-	-	-	-
6	F-PB6LB	F-PB6FA	-	F-PB6I	F-PB6Y	F-M3X040F	-	CMSG	DMSG	EMSG
10	F-PB10LB	F-PB10FA	F-PB10CJ	F-PB10I	F-PB10Y	F-M4X070F	F-M4X070U			
12	F-PB12LB	F-PB12FA	F-PB12CJ	F-PB12I	F-PB12Y	F-M5X080F	F-M5X080U			
16			F-PB16CJ							

### Accessory selection

Accessories Cylinder model	Mounting accessories	Knuckle						Sensor switch			
		LB	FA	CJ	I	Y	U [1]	F	CMSG	DMSG	EMSG
PB	Standard	●	●	●	●	●	●	●	×	×	×
	With magnet	●	●	●	●	●	●	●	●	●	●
PSB	Standard	●	●	●	●	●	●	●	×	×	×
PTB	With magnet	●	●	●	●	●	●	●	●	●	●
PBD	Standard	●	●	×	●	●	●	●	×	×	×
PBJ	With magnet	●	●	×	●	●	●	●	●	●	●

### Material of accessories

Accessories Bore size	Mounting accessories			Knuckle			
	LB	FA	CJ	I	Y	F	U
4~16	△	△	△	□	□	□	□

△—SPCC; □—Carbon steel;

[Note1] Please refer to P586-589 for knuckle detail.

### Dimensions

#### LB

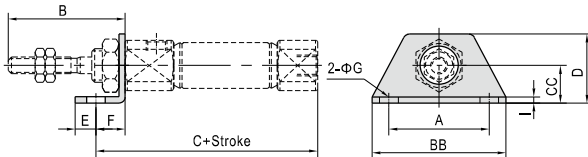

Bore size\Item	A	B	BB	C	CC	D	E	F	G	I
6	24	28	32	56.5	9	16.5	5	7	4.5	1.5
10	24	28	32	53	9	16.5	5	7	4.5	2
12	33	28	42	55	14	25	6	9	5.5	2.5
16	33	28	42	57	14	25	6	9	5.5	2.5

#### FA

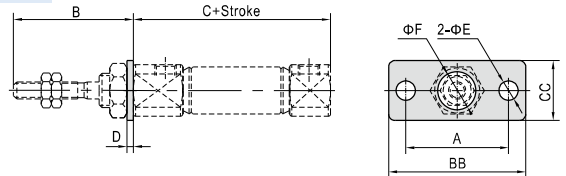

Bore size\Item	A	B	BB	C	CC	D	E	F
6	24	28	32	49.5	14	1.5	4.5	6.3
10	24	28	32	46	14	2	4.5	8.2
12	33	28	42	46	20	3	5.5	10.2
16	33	28	42	48	20	3	5.5	10.2

#### CJ

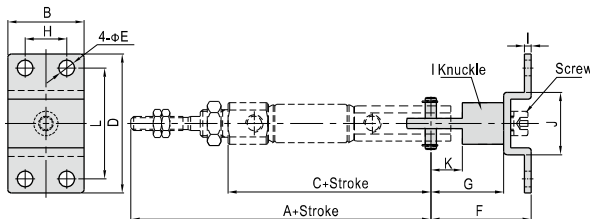

Bore size\Item	A	B	C	D	E	F	G	H	I	J	K	L
10	82	22	54	40	4.5	29	21	12	2	18	9.1	32
12	84	28	56	48	5.5	35	25	16	2.5	20.4	14.1	38
16	86	28	58	48	5.5	35	25	16	2.5	20.4	14.1	38

[Note] CJ type accessory includes I knuckle and PIN. It need to be matched with I knuckle and with relevant PIN.

#### I Knuckle

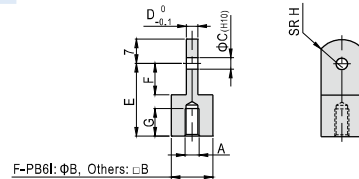

Bore size\Item	A	B	C	D	E	F	G	H
F-PB6I	M3×0.5	6	3	3	12	5	5	5
F-PB10I	M4×0.7	12	3.3	3	21	9.1	7.5	8
F-PB12I	M5×0.8	12	5	6.3	25	14.1	7.5	12

#### Y Knuckle

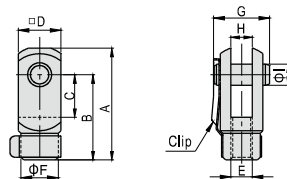

Bore size\Item	A	B	C	D	E	F	G	H	I
F-PB6Y	15.5	12	5	6	M3×0.5	6	9	3	3
F-PB10Y	28	21	10.2	12	M4×0.7	10	15.5	3.2	3.3
F-PB12Y	28	21	10.2	12	M5×0.8	10	15.5	6.5	5