

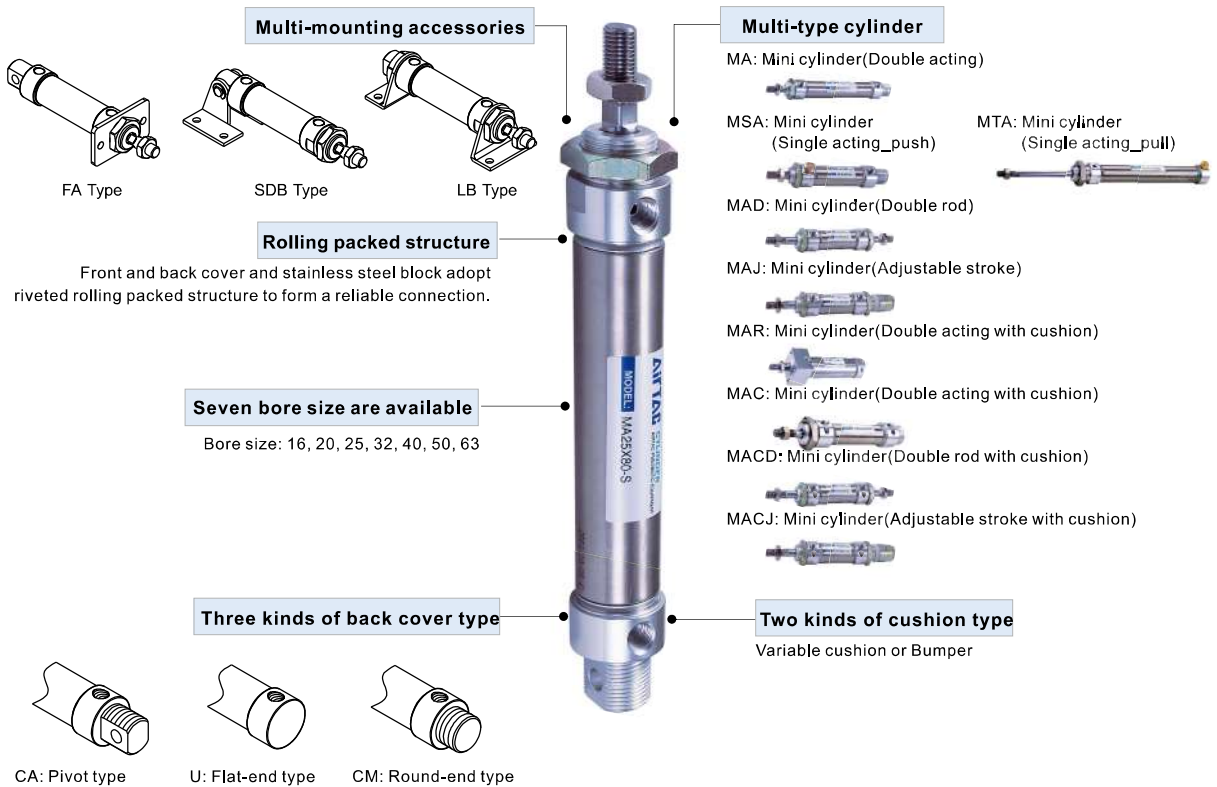

Mini cylinder—MA Series

Compendium of MA Series



Criteria for selection: Cylinder thrust

Unit : Newton(N)

Bore size	Rod size	Acting type	Pressure area(mm ²)	Operating pressure(MPa)							
				0.1	0.2	0.3	0.4	0.5	0.6	0.7	
16	6	Single Push side	201.0	-	-	20.1	40.2	60.3	80.4	100.5	
		Single Pull side	172.7	-	-	11.6	28.9	46.2	63.4	80.7	
		Double Push side	201.0	20.1	40.2	60.3	80.4	100.5	120.6	140.7	
		Double Pull side	172.7	17.3	34.5	51.8	69.1	86.4	103.6	120.9	
20	8	Single Push side	314.0	-	15.7	47.1	78.5	109.9	141.3	172.7	
		Single Pull side	263.8	-	5.7	32.0	58.4	84.8	111.2	137.5	
		Double Push side	314.0	31.4	62.8	94.2	125.6	157.0	188.4	219.8	
		Double Pull side	263.8	26.4	52.8	79.1	105.5	131.9	158.3	184.7	
25	10	Single Push side	490.6	-	24.6	73.7	122.8	171.8	220.9	269.9	
		Single Pull side	412.1	-	8.9	50.1	91.4	132.6	173.8	215.0	
		Double Push side	490.6	49.1	98.1	147.2	196.2	245.3	294.4	343.4	
		Double Pull side	412.1	41.2	82.4	123.6	164.8	206.1	247.3	288.5	
32	12	Single Push side	804.3	-	40.2	120.6	200.9	281.3	361.7	442.1	
		Single Pull side	691.2	-	17.6	86.6	155.7	224.8	293.9	363.0	
		Double Push side	804.3	80.4	160.9	241.3	321.7	402.2	482.6	563.0	
		Double Pull side	691.2	69.1	138.2	207.4	276.5	345.6	414.7	483.8	
40	16	Single Push side	1256.6	-	62.8	188.4	314.0	439.6	565.2	690.8	
		Single Pull side	1055.6	-	22.6	128.1	233.6	339.1	444.6	550.1	
		Double Push side	1256.6	125.7	251.3	377.0	502.6	628.3	754.0	879.6	
		Double Pull side	1055.6	105.6	211.1	316.7	422.2	527.8	633.4	738.9	
50	16	Double Push side	1962.5	196.3	392.5	588.8	785.0	981.3	1177.5	1373.8	
		Double Pull side	1761.5	176.2	352.3	528.5	704.6	880.8	1056.9	1233.1	
		Single Push side	3115.7	311.6	623.1	934.7	1246.3	1557.9	1869.4	2181.0	
		Single Pull side	2914.7	291.5	582.9	874.4	1165.9	1457.4	1748.8	2040.3	

Installation and application



- When load changes in the work, the cylinder with abundant output capacity shall be selected.
- Relative cylinder with high temperature resistance or corrosion resistance shall be chosen under the condition of high temperature or corrosion.
- Necessary protection measure shall be taken in the environment with higher humidity, much dust or water drops, oil dust and welding dregs.
- Dirty substances in the pipe must be eliminated before cylinder is connected with pipeline to prevent the entrance of particles into the cylinder.
- The medium used by cylinder shall be filtered to 40μm or below.
- Anti-freezing measure shall be adopted under low temperature environment to prevent moisture freezing.
- The cylinder shall be carried out test run without load before application. Prior to run, buffer shall be turned to the minimum and gradually released to avoid the damage on cylinder caused by excessive impact.
- To avoid side load, otherwise, piston rod will be bent and deformed and damage the thread at the end of the rod. Single-acting type can not be added in return.
- If the cylinder is dismantled and stored for a long time, please to conduct anti-rust treatment to the surface. Anti-dust caps shall be added in air inlet and outlet ports. The front and back cover can not be dismantled, which shall be especially noticed.



Mini cylinder

MA Series



Symbol

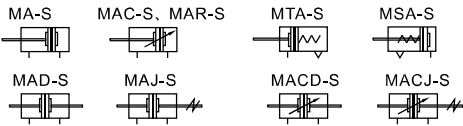

Product feature

- Standard cylinder manufactured by our enterprise.
- Piston adopts heterogeneous two-way seal structure. It has compact size and has the function of grease reservation.
- Front cover has fixed bumper which can reduce the impact of direction change of the cylinder.
- There are several modes of back cover, which makes the installation of cylinder more convenient.
- Front and back cover and stainless steel block adopt riveted rolling packed structure to form a reliable connection.
- The cylinder body has stainless steel pipes with high precision to produce high strength and corrosion resistance.
- There are cylinders and mounting accessories with several specifications for your choice.
- All cylinders of this series have magnet.

Specification

Bore size(mm)		16	20	25	32	40	50	63	
Acting type	MSA/MTA	Single acting						-	
	MA/MAD/MAJ	Double acting						-	
	MAR	-	Double acting						-
	MAC/MACD/MACJ	Double acting with cushion						-	
Fluid	Air(to be filtered by 40µm filter element)								
Operating pressure	Double acting	0.15~1.0MPa(22~145psi)(1.5~10.0bar)							
	Single acting	0.2~1.0MPa(28~145psi)(2.0~10.0bar)							
Proof pressure	1.5MPa(215psi)(15bar)								
Temperature °C	-20~70								
Speed range mm/s	Double acting : 30~800 Single acting : 50~800								
Stroke tolerance	0~150 ^{+1.0} ₀ >150 ^{+1.5} ₀								
Cushion type	MAC/MACD/MACJ Series: Variable cushion; Other series: Bumper								
Port size [Note1]	M5×0.8		1/8"			1/4"			

[Note1] PT thread, G thread and NPT thread are available.
Add) Refer to P362 for detail of sensor switch.

Stroke

Bore size (mm)	Standard stroke (mm)																Max. std. stroke	Max. stroke							
	16	20	25	30	40	50	60	75	80	100	125	150	160	175	200	250			300	350	400	450	500		
MAIMAC	16	20	25	30	40	50	60	75	80	100	125	150	160	175	200	250	300	350	400	450	500	500	600		
MA	20	10	15	20	25	30	40	50	60	75	80	100	125	150	160	175	200	250	300	350	400	450	500	500	800
MAC	25	10	15	20	25	30	40	50	60	75	80	100	125	150	160	175	200	250	300	350	400	450	500	500	800
MAR	32	10	15	20	25	30	40	50	60	75	80	100	125	150	160	175	200	250	300	350	400	450	500	500	800
	40	10	15	20	25	30	40	50	60	75	80	100	125	150	160	175	200	250	300	350	400	450	500	500	800
MAC	50	10	15	20	25	30	40	50	60	75	80	100	125	150	160	175	200	250	300	350	400	450	500	500	800
MAR	63	10	15	20	25	30	40	50	60	75	80	100	125	150	160	175	200	250	300	350	400	450	500	500	800
MAD	16	10	15	20	25	30	40	50	60	75	80	100	125	150	160	175	200	250	300					300	-
MAJ	20	10	15	20	25	30	40	50	60	75	80	100	125	150	160	175	200	250	300					300	-
MACD	25	10	15	20	25	30	40	50	60	75	80	100	125	150	160	175	200	250	300					300	-
MACJ	32	10	15	20	25	30	40	50	60	75	80	100	125	150	160	175	200	250	300	350	400	450	500	500	-
	40	10	15	20	25	30	40	50	60	75	80	100	125	150	160	175	200	250	300	350	400	450	500	500	-
MACD	50	10	15	20	25	30	40	50	60	75	80	100	125	150	160	175	200	250	300	350	400	450	500	500	-
MACJ	63	10	15	20	25	30	40	50	60	75	80	100	125	150	160	175	200	250	300	350	400	450	500	500	-
	16	10	15	20	25	30	40	50	60	75	80	100												-	-
	20	10	15	20	25	30	40	50	60	75	80	100	125	150										-	-
MSA	25	10	15	20	25	30	40	50	60	75	80	100	125	150										-	-
	32	10	15	20	25	30	40	50	60	75	80	100	125	150										-	-
	40	10	15	20	25	30	40	50	60	75	80	100	125	150										-	-
	16	10	15	20	25	30	40	50	60	75	80	100												-	-
	20	10	15	20	25	30	40	50	60	75	80	100												-	-
MTA	25	10	15	20	25	30	40	50	60	75	80	100												-	-
	32	10	15	20	25	30	40	50	60	75	80	100												-	-
	40	10	15	20	25	30	40	50	60	75	80	100												-	-

[Note] Consult us for non-standard stroke.

Ordering code

MA	20 × 50	S	CM	<input type="checkbox"/>	<input type="checkbox"/>
MAD	20 × 50	S		<input type="checkbox"/>	<input type="checkbox"/>
MAJ	20 × 50 - 20	S		<input type="checkbox"/>	<input type="checkbox"/>
MAR U	20 × 50	S		<input type="checkbox"/>	

① ② ③ ④ ⑤ ⑥ ⑦ ⑧ ⑨

① Model	② Front cover	③ Bore size	④ Stroke	⑤ Adjustable St.	⑥ Magnet	⑦ Back cover	⑧ Mounting type[Note1]	⑨ Thread type[Note2]		
MA: Mini cylinder(Double acting) MAC: Mini cylinder (Double acting with cushion) MSA: Mini cylinder(Single acting_push) MTA: Mini cylinder(Single acting_pull)	No this code	Model	Bore size	Refer to stroke table for details	No this code	S: With magnet	CA: Pivot type U: Flat-end type CM: Round-end type	Blank: No accessories FA: FA type SDB: SDB type LB: LB type		
MAD: Mini cylinder(Double rod) MACD: Mini cylinder (Double rod with cushion)		MAD	32							
		MAJ	40							
		MAD	16							
MAJ: Mini cylinder(Adjustable stroke) MACJ: Mini cylinder (Adjustable stroke with cushion)		MAD	16				Blank: No accessories FA: FA type LB: LB type	Blank: PT G: G T: NPT		
		MAC	20							
		MAR	25							
		MAR	32							
MAR: Mini cylinder (Double acting with cushion)	F: Front mounting U: Up mounting	MAR	40							
		MACD	50							
		MACJ	63				No this code			

[Note1] Please refer to page 92~93 for accessory parts.

[Note2] Standard thread is blank here.

Mini cylinder

MA Series

Inner structure and material of major parts

MA-CA

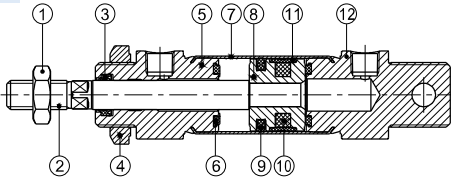

Note: inner structure & material data sheet is based on certain bore size. Please contact AirTAC if you need inner structure & material data sheet for specific bore size.

NO.	Item	Material
1	Rod nut	Stainless steel/Carbon steel
2	Piston rod	Carbon steel with 20μmchrome plated
3	Front cover packing	NBR
4	Front cover nut	Carbon steel
5	Front cover	Aluminum alloy
6	Bumper	TPU
7	Barrel	Stainless steel
8	Piston	Aluminum alloy
9	Piston seal	NBR
10	Magnet	Plastic
11	Wear ring	Wear resistant material
12	Back cover	Aluminum alloy

Dimensions

MA Φ16~Φ40

MAC Φ16~Φ40

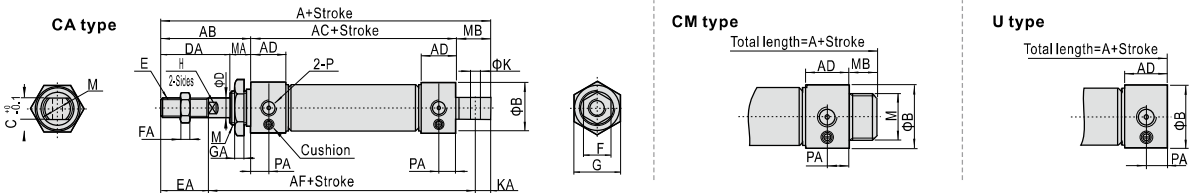

Bore size\Item Back cover	A																MA	MB		P	PA					
	CA	CM	U	AB	AC	AD	AF	B	C	D	DA	E	EA	F	FA	G		GA	H			K	KA	M	CA	CM
16	114	114	98	38	60	12.5	91	21	12	6	22	M6×1.0	16	10	5	22	6	5	6	7	M16×1.5	16	16	16	M5×0.8	7.5
20	137	128	116	40	76	16	108	27	16	8	28	M8×1.25	20	12	6	29	7	6	8	9	M22×1.5	12	21	12	1/8"	8
25	141	134	120	44	76	16	110	30	16	10	30	M10×1.25	22	17	6	29	7	8	8	9	M22×1.5	14	21	14	1/8"	8
32	147	134	120	44	76	16	113	35	16	12	30	M10×1.25	22	17	6	32	8	10	10	12	M24×2.0	14	27	14	1/8"	8
40	149	136	122	46	76	16.5	113	41.5	20	16	32	M12×1.25	24	17	7	41	8	14	12	12	M30×2.0	14	27	14	1/8"	9

MAC Φ50\Φ63

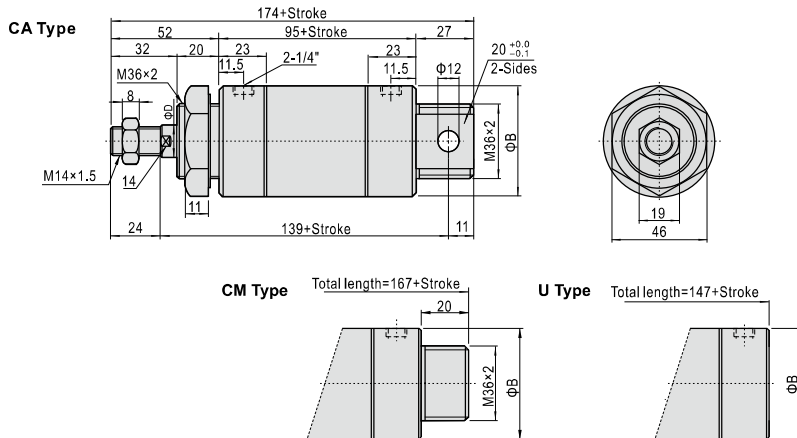

Bore size\Item	B	D
50	53	16
63	67	16

Mini cylinder

MA Series

MSA $\Phi 16\sim\Phi 40$

CA Type

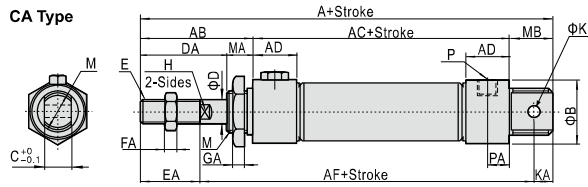

CM Type

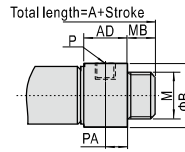

U Type

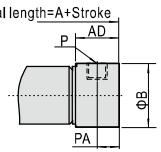

Item	A												AB	AC			AD	AF		
Back cover	CA			CM			U			-	-			-	-					
Bore size\Stroke	≤50	51~100	≥101	≤50	51~100	≥101	≤50	51~100	≥101	≤50	51~100	≥101	≤50	51~100	≥101	≤50	51~100	≥101		
16	139	164	-	139	164	-	123	148	-	38	85	110	-	12.5	116	141	-	-		
20	162	187	212	153	178	203	141	166	191	40	101	126	151	16	133	158	183	-		
25	166	191	216	159	184	209	145	170	195	44	101	126	151	16	135	160	185	-		
32	172	197	222	159	184	209	145	170	195	44	101	126	151	16	138	163	188	-		
40	174	199	224	161	186	211	147	172	197	46	101	126	151	16.5	138	163	188	-		

Bore size\Item	B	C	D	DA	E	EA	F	FA	G	GA	H	K	KA	M	MA	MB		P	PA
Back cover																CA	CM		
16	21	12	6	22	M6×1.0	16	10	5	22	6	5	6	7	M16×1.5	16	16	16	M5×0.8	7.5
20	27	16	8	28	M8×1.25	20	12	6	29	7	6	8	9	M22×1.5	12	21	12	1/8"	8
25	30	16	10	30	M10×1.25	22	17	6	29	7	8	8	9	M22×1.5	14	21	14	1/8"	8
32	35	16	12	30	M10×1.25	22	17	6	32	8	10	10	12	M24×2.0	14	27	14	1/8"	8
40	41.5	20	16	32	M12×1.25	24	17	7	41	8	14	12	12	M30×2.0	14	27	14	1/8"	9

MTA $\Phi 16\sim\Phi 40$

CA Type

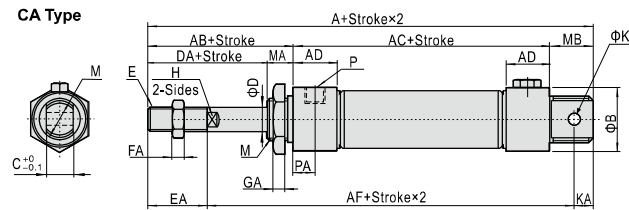

CM Type

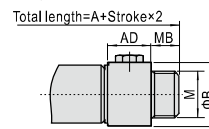

U Type

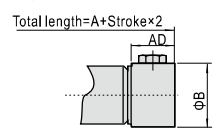

Item	A												AC				AF			
Back cover	CA			CM			U			-				-						
Bore size\Stroke	≤25	≤50	≤75	≤100	≤25	≤50	≤75	≤100	≤25	≤50	≤75	≤100	≤25	≤50	≤75	≤100	≤25	≤50	≤75	≤100
16	129	139	154	164	129	139	154	164	113	123	138	148	75	85	100	110	106	116	131	141
20	152	162	177	187	143	153	168	178	131	141	156	166	91	101	116	126	123	133	148	158
25	156	166	181	191	149	159	174	184	135	145	160	170	91	101	116	126	125	135	150	160
32	162	172	192	202	149	159	179	189	135	145	165	175	91	101	121	131	128	138	158	168
40	164	174	194	204	151	161	181	191	137	147	167	177	91	101	121	131	128	138	158	168

Bore size\Item	AB	AD	B	C	D	DA	E	EA	F	FA	G	GA	H	K	KA	M	MA	MB		P	PA
Back cover																		CA	CM		
16	38	12.5	21	12	6	22	M6×1.0	16	10	5	22	6	5	6	7	M16×1.5	16	16	16	M5×0.8	7.5
20	40	16	27	16	8	28	M8×1.25	20	12	6	29	7	6	8	9	M22×1.5	12	21	12	1/8"	8
25	44	16	30	16	10	30	M10×1.25	22	17	6	29	7	8	8	9	M22×1.5	14	21	14	1/8"	8
32	44	16	35	16	12	30	M10×1.25	22	17	6	32	8	10	10	12	M24×2.0	14	27	14	1/8"	8
40	46	16.5	41.5	20	16	32	M12×1.25	24	17	7	41	8	14	12	12	M30×2.0	14	27	14	1/8"	9

Mini cylinder

MA Series

MAD/MACD

Φ16~Φ40

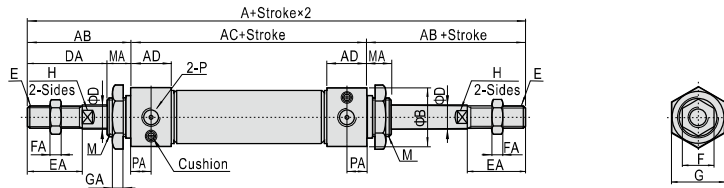

Φ50/Φ63

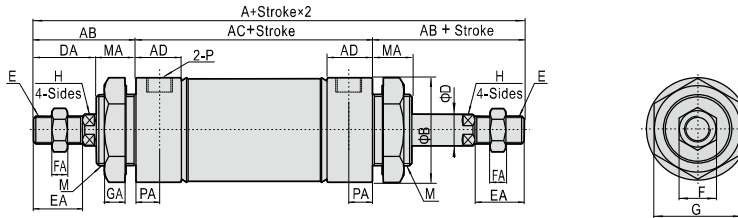

Bore size/Item	A	AB	AC	AD	B	D	DA	E	EA	F	FA	G	GA	H	M	MA	P	PA
16	136	38	60	12.5	21	6	22	M6×1.0	16	10	5	22	6	5	M16×1.5	16	M5×0.8	7.5
20	156	40	76	16	27	8	28	M8×1.25	20	12	6	29	7	6	M22×1.5	12	1/8"	8
25	164	44	76	16	30	10	30	M10×1.25	22	17	6	29	7	8	M22×1.5	14	1/8"	8
32	164	44	76	16	35	12	30	M10×1.25	22	17	6	32	8	10	M24×2.0	14	1/8"	8
40	168	46	76	16.5	41.5	16	32	M12×1.25	24	17	7	41	8	14	M30×2.0	14	1/8"	9
50	199	52	95	23	53	16	32	M14×1.5	24	19	8	46	11	14	M36×2.0	20	1/4"	11.5
63	199	52	95	23	67	16	32	M14×1.5	24	19	8	46	11	14	M36×2.0	20	1/4"	11.5

MAJ/MACJ

Φ16~Φ40

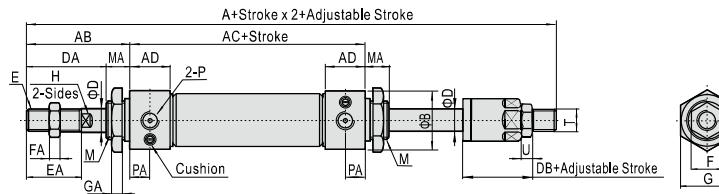

Φ50/Φ63

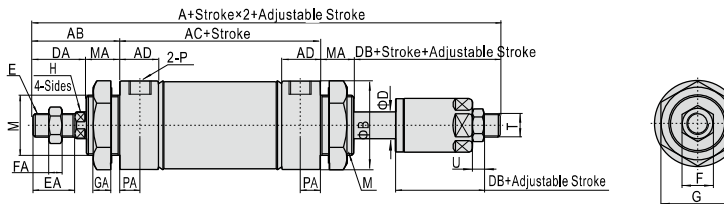

Bore size/Item	A	AB	AC	AD	B	D	DA	DB	E	EA	F	FA	H	M	MA	P	PA	G	GA	T	U
16	135	38	60	12.5	21	6	22	21	M6×1.0	16	10	5	5	M16×1.5	16	M5×0.8	7.5	22	6	M6×1.0	5
20	153	40	76	16	27	8	28	25	M8×1.25	20	12	6	6	M22×1.5	12	1/8"	8	29	7	M8×1.25	6
25	161	44	76	16	30	10	30	27	M10×1.25	22	17	6	8	M22×1.5	14	1/8"	8	29	7	M10×1.25	6
32	161	44	76	16	35	12	30	27	M10×1.25	22	17	6	10	M24×2.0	14	1/8"	8	32	8	M10×1.25	6
40	164	46	76	16.5	41.5	16	32	28	M12×1.25	24	17	7	14	M30×2.0	14	1/8"	9	41	8	M12×1.25	7
50	195	52	95	23	53	16	32	28	M14×1.5	24	19	8	14	M36×2.0	20	1/4"	11.5	46	11	M12×1.25	7
63	195	52	95	23	67	16	32	28	M14×1.5	24	19	8	14	M36×2.0	20	1/4"	11.5	46	11	M12×1.25	7

Mini cylinder

MA Series

MARU(Up mounting type)

Φ20~Φ40

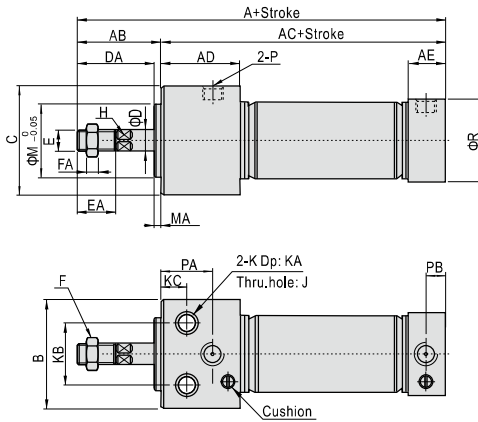

Bore size/Item	A	AB	AC	AD	AE	B	C	D	DA	E	EA	F	FA
20	120	31	89	29	16	33.5	30.5	8	28	M8×1.25	20	13	5
25	122	33	89	29	16	39	36.5	10	30	M10×1.25	22	17	6
32	122	33	89	29	16	47	42.5	12	30	M10×1.25	22	17	6
40	132.5	35	97.5	37.5	16.5	58.5	52.5	16	32	M14×1.5	24	19	8

Bore size/Item	H	J	K	KA	KB	KC	M	MA	P	PA	PB	R
20	6	Φ5.5	Φ9.5	6.5	21	12	20	3	1/8"	22	8	27
25	8	Φ6.5	Φ11.0	7.5	25	12	26	3	1/8"	22	8	30
32	10	Φ9.0	Φ14.0	10	30	12	26	3	1/8"	22	8	35
40	14	Φ11	Φ17.5	12.5	38	15	32	3	1/8"	27	9	41.5

MARF(Front mounting type)

Φ20~Φ40

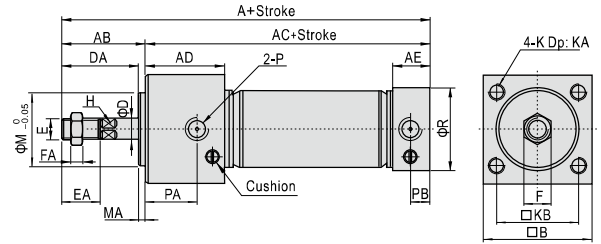

Bore size/Item	A	AB	AC	AD	AE	B	D	DA	E	EA
20	120	31	89	29	16	30.5	8	28	M8×1.25	20
25	122	33	89	29	16	36.5	10	30	M10×1.25	22
32	122	33	89	29	16	42.5	12	30	M10×1.25	22
40	132.5	35	97.5	37.5	16.5	52.5	16	32	M14×1.5	24

Bore size/Item	F	FA	H	K	KA	KB	M	MA	P	PA	PB	R
20	13	5	6	M5×0.8	9	22	20	3	1/8"	22	8	27
25	17	6	8	M6×1.0	11	26	26	3	1/8"	22	8	30
32	17	6	10	M6×1.0	11	30	26	3	1/8"	22	8	35
40	19	8	14	M8×1.25	14	36	32	3	1/8"	27	9	41.5

Φ50/Φ63

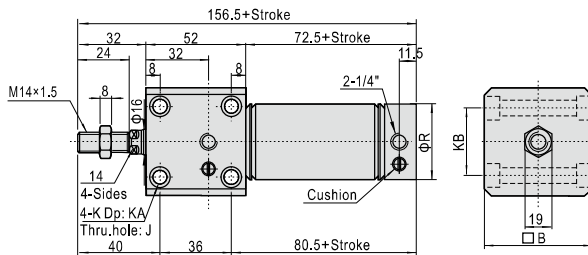

Bore size/Item	B	J	K	KA	KB	R
50	62	Φ6.5	2-Sides: Φ11.0	6.5	44	53
63	74	Φ9.0	2-Sides: Φ14.0	8.5	48	67

Φ50/Φ63

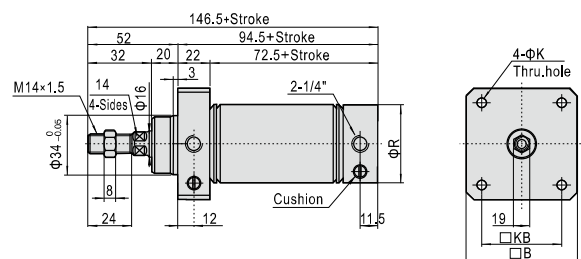

Bore size/Item	B	K	KB	R
50	62	6.5	48	53
63	74	9.0	58	67

Mini cylinder

MA Series—Accessories

List for ordering code of accessories

Accessories Bore size	Mounting accessories			Knuckle				Sensor switch		
	LB	FA	SDB	I	Y	F	U	CMSG	DMSG	EMSG
16	F-MA16LB	F-MA16FA	F-MA16SDB	F-MA16I	F-MA16Y	F-M6X100F	F-M6X100U	CMSG	DMSG	EMSG
20	F-MA20LB	F-MA20FA	F-MA20SDB	F-MA20I	F-MA20Y	F-M8X125F	F-M8X125U			
25				F-MA25I	F-MA25Y	F-M10X125F	F-M10X125U			
32	F-MA32LB	F-MA32FA	F-MA32SDB	F-MA40I	F-MA40Y	F-M12X125F	F-M12X125U			
40	F-MA40LB	F-MA40FA								
50	F-MA50LB	F-MA50FA	F-MA40SDB	F-MAC50I	F-MAC50Y	F-M14X150F	F-M14X150U			
63	F-MA63LB									

Accessory selection

Accessories Cylinder model	Mounting accessories			Knuckle[Note1]				Sensor switch		
	LB	FA	SDB	I	Y	U	F	CMSG	DMSG	EMSG
MA\MAC	•	•	•	•	•	•	•	•	•	•
MSA\MTA	•	•	•	•	•	•	•	•	•	•
MAD\MACD	•	•	x	•	•	•	•	•	•	•
MAJ\MACJ	•	•	x	•	•	•	•	•	•	•
MARF\MARU	x	x	x	•	•	•	•	•	•	•

Material of accessories

Accessories Bore size	Mounting accessories			Knuckle			
	LB	FA	SDB	I	Y	F	U
16~63	○	○	○	□	□	□	□

○—Lower carbon steel ; □—Carbon steel ;

[Note1] Please refer to P358~361 for knuckle detail.

Dimensions

LB

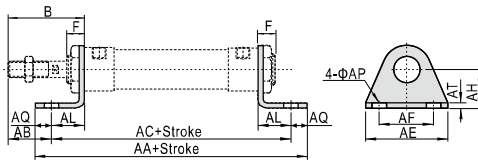

Bore size\Item Stroke	AA	AA(MSA)			AC	AC(MSA)		
	(MA\MAC)	0~50	51~100	101~150	(MAMAC)	0~50	51~100	101~150
16	98	123	148	-	86	111	136	-
20	122	147	172	197	106	131	156	181
25	122	147	172	197	106	131	156	181
32	142	167	192	217	126	151	176	201
40	142	167	192	217	126	151	176	201
50	175	-	-	-	151	-	-	-
63	183	-	-	-	157	-	-	-

Bore size\Item Stroke	B	F	AB	AE	AF	AL	AQ	AP	AT	AH
	16	38	16	25	44	32	13	6	5.5	2.5
20	40	12	25	54	40	15	8	6.5	3	25
25	44	14	29	54	40	15	8	6.5	3	25
32	44	14	19	59	45	25	8	7	3.5	32
40	46	14	21	64	50	25	8	7	3.5	36
50	52	20	24	86	66	28	12	11	4.5	40
63	52	20	21	106	82	31	13	11	4.5	45

FA

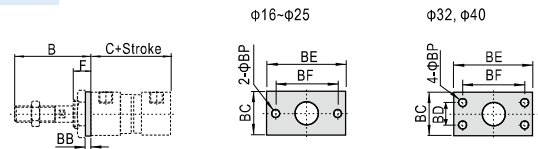

Bore size\Item Stroke	B	C	C(MSA)			BB	BC	BD	BE	BF	BP	F
	(MAMAC)	0~50	51~100	101~150								
16	38	60	85	110	-	3	26	-	52	40	5.5	16
20	40	76	101	126	151	3.5	38	-	64	50	7	12
25	44	76	101	126	151	3.5	38	-	64	50	7	14
32	44	76	101	126	151	4	47	33	72	58	6.5	14
40	46	76	101	126	151	4	50	36	84	70	6.5	14
50	54	147				4.5	65	47	104	86	9	22
63	54	147				4.5	65	47	104	86	9	22

SDB

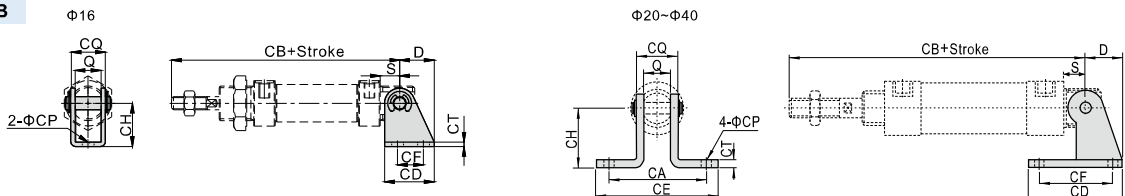

Bore size\Item Stroke	D	S	Q	CA	CB	CB(MSA)			CD	CE	CF	CH	CT	CP	CQ
	(MA)	0~50	51~100	101~150											
16	16	9	12	-	107	132	157	-	23	-	12	20	2	5.5	16
20	21	12	16	51	128	153	178	203	48	67	32	32	2.5	7	21
25	21	12	16	51	132	157	182	207	48	67	32	32	2.5	7	21
32	27	15	16	51	135	160	185	210	52	67	36	36	3	7	22
40	27	15	20	55	137	162	187	212	56	71	40	40	3	7	26

[Note] SDB is attached with relevant PIN.

Mini cylinder

MA Series—Accessories

I Knuckle

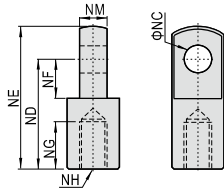

Type\Item	NC	ND	NE	NF	NG	NH	NM
F-MA16I	5	21	28	8.5	8	M6×1.0	6
F-MA20I	8	30	40	11	15	M8×1.25	8
F-MA25I	10	40	50	15	20	M10×1.25	10
F-MA40I	10	45	57	16	23	M12×1.25	14

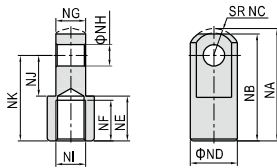

Type\Item	NA	NB	NC	ND	NE	NF	NG	NH	NJ	NK	NI
F-MAC50I	52.5	50	12.5	22	21	19	13.8	10	19	40	M14×1.5

Y Knuckle

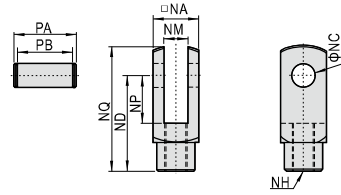

Type\Item	NA	NC	ND	NP	NQ	NM	NH	PA	PB
F-MA16Y	12	5	21	8.5	27.4	6	M6×1.0	16.8	12.4
F-MA40Y	25.4	10	45	20	57	14	M12×1.25	32	26.2

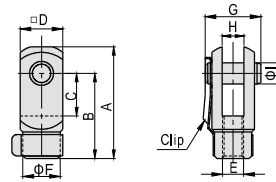

Type\Item	A	B	C	D	E	F	G	H	I
F-MA20Y	42	32	16	16	M8×1.25	14	21	8	8
F-MA25Y	52	40	20	19	M10×1.25	18	25	10	10

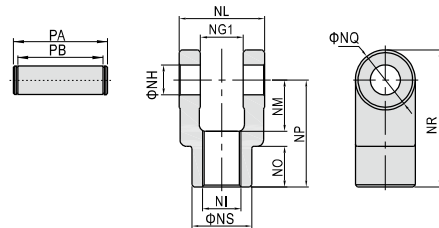

Type\Item	Ng1	NH	NI	NL	NM	NO	NP	NQ	NR	NS	PA	PB
F-MAC50Y	14.2	10	M14×1.5	27.8	19	17	40	22	51	22	34.6	28.8