



Mini cylinder—MG Series

Compendium of MG Series

Multi-mounting accessories

LB Type FA Type
SDB+CB Type CB Type

Multi-type cylinder

- MG: Mini cylinder(Double acting)
- MSG: Mini cylinder (Single acting_push)
- MTG: Mini cylinder(Single acting_pull)
- MGD: Mini cylinder(Double rod)
- MGC: Mini cylinder(Double acting with cushion)
- MGCD: Mini cylinder(Double rod with cushion)

Six bore size are available

Bore size: 20, 25, 32, 40, 50, 63

Rolling packed structure

Front and back cover and stainless steel block adopt riveted rolling packed structure to form a reliable connection.

Two kinds of cushion type

Variable cushion or Bumper

Criteria for selection: Cylinder thrust

Unit: Newton(N)

Bore size	Rod size	Acting type	Pressure area(mm ²)	Operating pressure(MPa)							
				0.1	0.2	0.3	0.4	0.5	0.6	0.7	
20	8	Single acting	Push side	314.0	-	15.7	47.1	78.5	109.9	141.3	172.7
			Pull side	263.8	-	5.7	32.0	58.4	84.8	111.2	137.5
		Double acting	Push side	314.0	31.4	62.8	94.2	125.6	157.0	188.4	219.8
			Pull side	263.8	26.4	52.8	79.1	105.5	131.9	158.3	184.7
25	10	Single acting	Push side	490.6	-	24.6	73.7	122.8	171.8	220.9	269.9
			Pull side	412.1	-	8.9	50.1	91.4	132.6	173.8	215.0
		Double acting	Push side	490.6	49.1	98.1	147.2	196.2	245.3	294.4	343.4
			Pull side	412.1	41.2	82.4	123.6	164.8	206.1	247.3	288.5
32	12	Single acting	Push side	804.3	-	40.2	120.6	200.9	281.3	361.7	442.1
			Pull side	691.2	-	17.6	86.6	155.7	224.8	293.9	363.0
		Double acting	Push side	804.3	80.4	160.9	241.3	321.7	402.2	482.6	563.0
			Pull side	691.2	69.1	138.2	207.4	276.5	345.6	414.7	483.8
40	16	Single acting	Push side	1256.6	-	62.8	188.4	314.0	439.6	565.2	690.8
			Pull side	1055.6	-	22.6	128.1	233.6	339.1	444.6	550.1
		Double acting	Push side	1256.6	125.7	251.3	377.0	502.6	628.3	754.0	879.6
			Pull side	1055.6	105.6	211.1	316.7	422.2	527.8	633.4	738.9
50	20	Double acting	Push side	1962.5	196.3	392.5	588.8	785.0	981.3	1177.5	1373.8
			Pull side	1648.5	164.9	329.7	494.6	659.4	824.3	989.1	1154.0
63	20	Double acting	Push side	3115.7	311.6	623.1	934.7	1246.3	1557.9	1869.4	2181.0
			Pull side	2801.7	280.2	560.3	840.5	1120.7	1400.9	1681.0	1961.2

Installation and application



1. When load changes in the work, the cylinder with abundant output capacity shall be selected.
2. Relative cylinder with high temperature resistance or corrosion resistance shall be chosen under the condition of high temperature or corrosion.
3. Necessary protection measure shall be taken in the environment with higher humidity, much dust or water drops, oil dust and welding dregs.
4. Dirty substances in the pipe must be eliminated before cylinder is connected with pipeline to prevent the entrance of particles into the cylinder.
5. The medium used by cylinder shall be filtered to 40μm or below.
6. Anti-freezing measure shall be adopted under low temperature environment to prevent moisture freezing.
7. The cylinder shall be carried out test run without load before application. Prior to run, buffer shall be turned to the minimum and gradually released to avoid the damage on cylinder caused by excessive impact.
8. To avoid side load, otherwise, piston rod will be bent and deformed and damage the thread at the end of the rod. Single-acting type can not be added in return.
9. If the cylinder is dismantled and stored for a long time, please conduct anti-rust treatment to the surface. Anti-dust caps shall be added in air inlet and outlet ports. The front and back cover can not be dismantled, which shall be especially noticed.





Specification

Bore size(mm)		20	25	32	40	50	63	
Acting type	MSG/MTG	Single acting					-	
	MG/MGD	Double acting					-	
	MGC/MGCD	Double acting with cushion					-	
Fluid		Air(to be filtered by 40μm filter element)						
Operating pressure	Double acting	0.15~1.0MPa(22~145psi)(1.5~10.0bar)						
	Single acting	0.2~1.0MPa(28~145psi)(2.0~10.0bar)						
Proof pressure		1.5MPa(215psi)(15bar)						
Temperature °C		-20~70						
Speed range mm/s		Double acting: 30~800 Single acting: 50~800						
Stroke tolerance		0~150 ^{+1.0} / ₀ >150 ^{+1.5} / ₀						
Cushion type		Variable cushion、Bumper				Variable cushion		
Port size [Note1]	Variable cushion	M5×0.8	1/8"			1/4"		
	Bumper	1/8"			-			

[Note1] G thread is available.
Add) Refer to P590 for detail of sensor switch.

Symbol

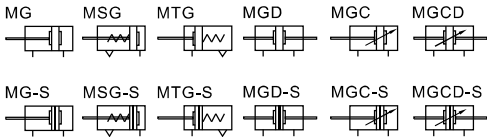

Stroke

Bore size (mm)	stroke (mm)											Max.std stroke	Max. stroke								
	Standard stroke													Longer stroke							
MG	20	10	15	20	25	30	40	50	60	75	80	100	125	150	175	200	201~500	500	800		
	25	10	15	20	25	30	40	50	60	75	80	100	125	150	175	200	250	300	301~500	500	800
	32	10	15	20	25	30	40	50	60	75	80	100	125	150	175	200	250	300	301~500	500	800
	40	10	15	20	25	30	40	50	60	75	80	100	125	150	175	200	250	300	301~500	500	800
	50	10	15	20	25	30	40	50	60	75	80	100	125	150	175	200	250	300	301~500	500	800
	63	10	15	20	25	30	40	50	60	75	80	100	125	150	175	200	250	300	301~500	500	800
MGD	20	10	15	20	25	30	40	50	60	75	80	100	125	150	175	200	250	300	-	300	-
	25	10	15	20	25	30	40	50	60	75	80	100	125	150	175	200	250	300	-	300	-
	32	10	15	20	25	30	40	50	60	75	80	100	125	150	175	200	250	300	-	500	-
	40	10	15	20	25	30	40	50	60	75	80	100	125	150	175	200	250	300	-	500	-
	50	10	15	20	25	30	40	50	60	75	80	100	125	150	175	200	250	300	-	500	-
	63	10	15	20	25	30	40	50	60	75	80	100	125	150	175	200	250	300	-	500	-
MSG	20	10	15	20	25	30	40	50	60	75	80	100	125	150	-	-	-				
	25	10	15	20	25	30	40	50	60	75	80	100	125	150	-	-	-				
	32	10	15	20	25	30	40	50	60	75	80	100	125	150	-	-	-				
	40	10	15	20	25	30	40	50	60	75	80	100	125	150	-	-	-				
	50	10	15	20	25	30	40	50	60	75	80	100	125	150	-	-	-				
	63	10	15	20	25	30	40	50	60	75	80	100	125	150	-	-	-				
MTG	20	10	15	20	25	30	40	50	60	75	80	100	125	150	-	-	-				
	25	10	15	20	25	30	40	50	60	75	80	100	125	150	-	-	-				
	32	10	15	20	25	30	40	50	60	75	80	100	125	150	-	-	-				
	40	10	15	20	25	30	40	50	60	75	80	100	125	150	-	-	-				
	50	10	15	20	25	30	40	50	60	75	80	100	125	150	-	-	-				
	63	10	15	20	25	30	40	50	60	75	80	100	125	150	-	-	-				

[Note] Consult us for non-standard stroke.

Product feature

- JIS standard is implemented.
- Piston adopts heterogeneous two way seal structure. It has compact size and has the function of oil reservation.
- Front cover owns fixed anti-impact pad which can reduce the impact of direction-change of the cylinder.
- Front and back cover and stainless steel block adopt riveted rolling packed structure to form a reliable connection.
- The cylinder body has stainless steel pipes with high precision to produce high strength and corrosion resistance.
- There are cylinders and mounting accessories with several specifications for your choice.

Ordering code

MG 20 × 100 S FA G

① ② ③ ④ ⑤ ⑥

① Model	② Bore size		③ Stroke	④ Magnet	⑤ Mounting type [Note1]	⑥ Thread type [Note2]
MG: Mini cylinder(Double acting) MGC: Mini cylinder (Double acting with cushion)	Model	Bore size	Refer to stroke table for details	Blank: Without magnet S: With magnet	Blank: No accessories FA: FA type LB: LB type CB: CB type SDB: SDB type	G: G Thread
MSG: Mini cylinder (Single acting_push) MTG: Mini cylinder (Single acting_pull)	MG	20				
	MSG	25				
	MTG	32				
	MGD	40				
MGD: Mini cylinder(Double rod) MGCD: Mini cylinder (Double rod with cushion)	MGC	20 25				
	MGCD	32 40				
		50 63				

[Note1] Please refer to page 335~336 for accessory parts, SDB must be used with CB.

[Note2] Standard thread is blank here.

Mini cylinder

MG Series

Inner structure and material of major parts

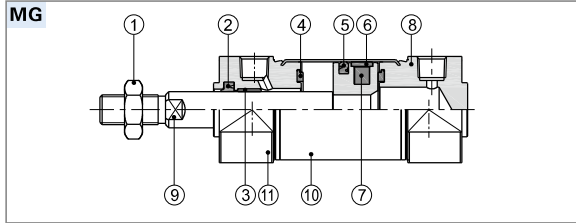

NO.	Item	Material
1	Rod nut	Carbon steel
2	Front cover packing	NBR
3	Bushing	Wear resistant material
4	Bumper	TPU
5	Piston seal	NBR
6	Wear ring	Wear resistant material
7	Magnet	Rubber
8	Back cover	Aluminum alloy
9	Piston rod	Carbon steel with 20 μm chrome plated
10	Barrel	SUS304
11	Front cover	Aluminum alloy

Note: inner structure & material data sheet is based on certain bore size.
Please contact AirTAC if you need inner structure & material data sheet for specific bore size.

Dimensions

MG $\phi 20 \sim \phi 40$

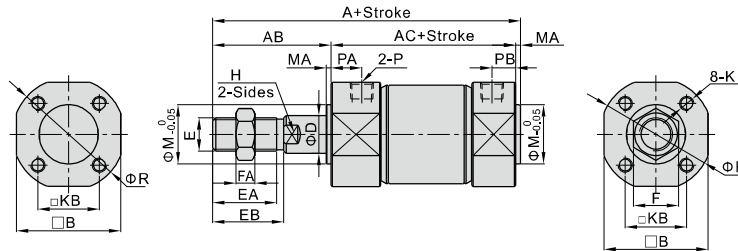

MGC $\phi 20 \sim \phi 63$

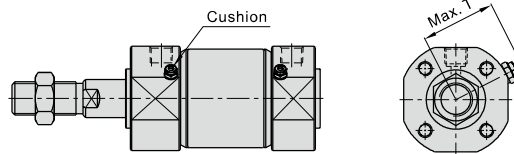

Bore size/Item	Standard stroke	Longer stroke	A	AB	AC	B	D	E	EA	EB	F	FA
20	≤200	201~500	106(114)	35	69(77)	24	8	M8×1.25	16.5	18	12	6
25	≤300	301~500	111(119)	40	69(77)	29	10	M10×1.25	20.5	22	17	6
32	≤300	301~500	113(121)	40	71(79)	35.5	12	M10×1.25	20.5	22	17	6
40	≤300	301~500	130(139)	50	78(87)	44	16	M14×1.5	28.5	30	19	8
50	≤300	301~500	150(162)	58	90(102)	55	20	M18×1.5	33.5	35	27	11
63	≤300	301~500	150(162)	58	90(102)	69	20	M18×1.5	33.5	35	27	11

Bore size/Item	H	K	KB	M	MA	P		PA		PB		R	T
						MG	MGC	MG	MGC	MG	MGC		
20	6	M4×0.7 dp:7	14	12	2	1/8"	M5×0.8	11.5(14)	14(16.5)	8	10	26.5	22.5
25	8	M5×0.8 dp:7.5	16.5	14	2	1/8"	PT1/8	11.5(14.5)	11.5(14.5)	8.5	8.5	31.5	24.5
32	10	M5×0.8 dp:7.5	20	18	2	1/8"	PT1/8	12(14.5)	12(14.5)	9.5	9.5	38.5	30.5
40	14	M6×1.0 dp:12	26	25	2	1/8"	PT1/8	13(13.5)	13(13.5)	12	12	47.5	35
50	18	M8×1.25 dp:16	32	30	2	-	PT1/4	-	15.5(22.5)	-	13	58.5	40.5
63	18	M10×1.5 dp:16	38	32	2	-	PT1/4	-	15.5(22.5)	-	13	72	47.5

Remark: The dimensions of magnet type cylinder are the same as non-magnet type cylinder. The values in the "()" are for longer strokes.

Mini cylinder

MG Series

MSG $\Phi 20\sim\Phi 40$

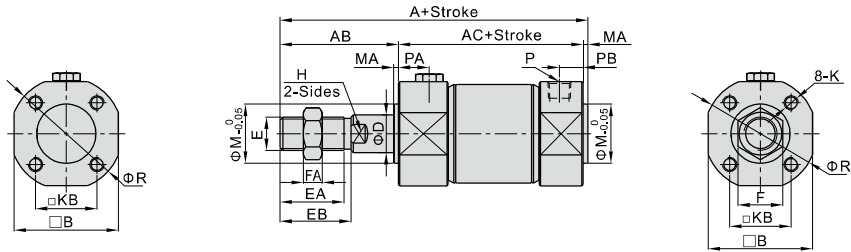

MTG $\Phi 20\sim\Phi 40$

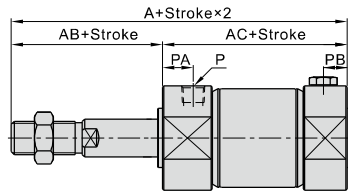

Bore size\Item	A				AB	AC				B	D	E	EA	EB	F	FA	H	K	KB	M	MA	P	PA	PB	R
	1~50	51~100	101~150	150		1~50	51~100	101~150	150																
20	131	156	181	35	94	119	144	24	8	M8×1.25	16.5	18	12	6	6	M4×0.7 Dp:7	14	12	2	1/8"	11.5	8	26.5		
25	136	161	186	40	94	119	144	29	10	M10×1.25	20.5	22	17	6	8	M5×0.8 Dp:7.5	16.5	14	2	1/8"	11.5	8.5	31.5		
32	138	163	188	40	96	121	146	35.5	12	M10×1.25	20.5	22	17	6	10	M5×0.8 Dp:7.5	20	18	2	1/8"	12	9.5	38.5		
40	155	180	205	50	103	128	153	44	16	M14×1.5	28.5	30	19	8	14	M6×1.0 Dp:12	26	25	2	1/8"	13	12	47.5		

Remark: The dimensions of magnet type cylinder are the same as non-magnet type cylinder.

MGD $\Phi 20\sim\Phi 40$

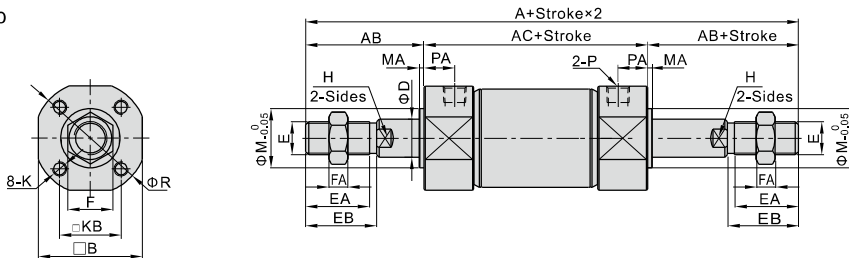

MGCD $\Phi 20\sim\Phi 63$

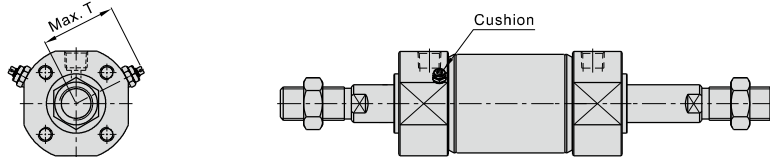

Bore size\Item	A	AC	AB	B	D	E	EA	EB	F	FA	H	K	KB	M	MA	P		PA		R	T
																MGD	MGCD	MGD	MGCD		
20	147	77	35	24	8	M8×1.25	16.5	18	12	6	6	M4×0.7 Dp:7	14	12	2	1/8"	M5×0.8	11.5	14	26.5	22.5
25	157	77	40	29	10	M10×1.25	20.5	22	17	6	8	M5×0.8 Dp:7.5	16.5	14	2	1/8"	1/8"	11.5	11.5	31.5	24.5
32	159	79	40	35.5	12	M10×1.25	20.5	22	17	6	10	M5×0.8 Dp:7.5	20	18	2	1/8"	1/8"	12	12	38.5	30.5
40	187	87	50	44	16	M14×1.5	28.5	30	19	8	14	M6×1.0 Dp:12	26	25	2	1/8"	1/8"	13	13	47.5	35
50	218	102	58	55	20	M18×1.5	33.5	35	27	11	18	M8×1.25 Dp:16	32	30	2	-	1/4"	-	15.5	58.5	40.5
63	218	102	58	69	20	M18×1.5	33.5	35	27	11	18	M10×1.5 Dp:16	38	32	2	-	1/4"	-	15.5	72	47.5

Remark: The dimensions of magnet type cylinder are the same as non-magnet type cylinder.

List for ordering code of accessories

Accessories Bore size	Mounting accessories				Knuckle		Sensor switch		
	LB	FA	SDB	CB	I	Y	CMSG	DMSG	EMSG
20	F-MG20LB	F-MG20FA	F-MG20SDB	F-MG20CB	F-ACQ20I	F-ACQ20Y	CMSG	DMSG	EMSG
25	F-MG25LB	F-MG25FA	F-MG25SDB	F-MG25CB	F-ACQ25I	F-ACQ25Y			
32	F-MG32LB	F-MG32FA	F-MG32SDB	F-MG32CB	F-ACQ32I	F-ACQ32Y			
40	F-MG40LB	F-MG40FA	F-MG40SDB	F-MG40CB	F-ACQ32I	F-ACQ32Y			
50	F-MG50LB	F-MG50FA	F-MG50SDB	F-MG50CB	F-ACQ50I	F-ACQ50Y			
63	F-MG63LB	F-MG63FA	F-MG63SDB	F-MG63CB					

Accessory selection

Accessories Cylinder model		Mounting accessories				Knuckle		Sensor switch		
		LB	FA	SDB	CB	I	Y	CMSG	DMSG	EMSG
MG	Standard	•	•	•	•	•	•	•	•	•
MGC	With magnet	•	•	•	•	•	•	•	•	•
MSG	Standard	•	•	•	•	•	•	•	•	•
MTG	With magnet	•	•	•	•	•	•	•	•	•
MGD	Standard	•	•	x	x	•	•	•	•	•
MGCD	With magnet	•	•	x	x	•	•	•	•	•

Material of accessories

Accessories Bore size	Mounting accessories				Knuckle	
	LB	FA	SDB	CB	I	Y
20 25	△	○	△	△	□	□
32-63	△	○	△	△	□	□

△—SPCC ; ○—cast iron ; □—S45C ; ◊—cast steel

Dimensions

LB

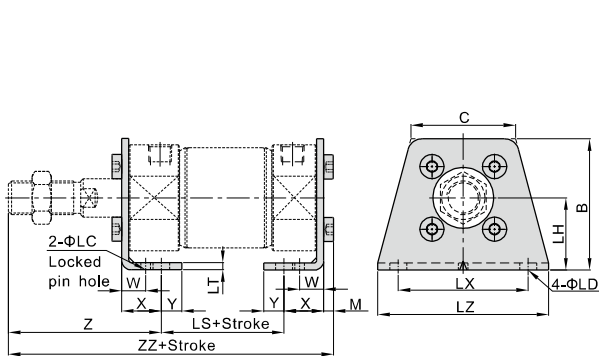

FA\FB

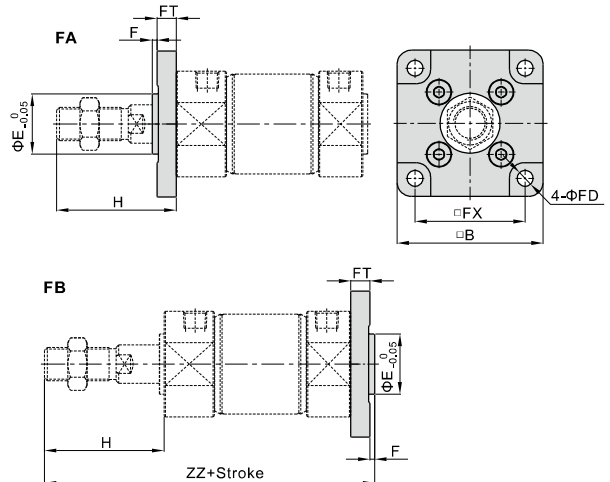

Bore size/Item	Standard stroke	Longer stroke	B	C	LC	LD	LH	LS
20	≤200	201~500	34	27.5	4	6	20	45(53)
25	≤300	301~500	38.5	30	4	6	22	45(53)
32	≤300	301~500	45	35.5	4	7	25	46(54)
40	≤300	301~500	54.5	43.5	4	7	30	52(61)
50	≤300	301~500	70.5	50.5	5	10	40	55(67)
63	≤300	301~500	82.5	64	5	12	45	55(67)

Bore size/Item	Standard stroke	Longer stroke	B	E	F	FD	FX	FT	H	ZZ
20	≤200	201~500	40	12	2	5.5	28	6	35	112(120)
25	≤300	301~500	44	14	2	5.5	32	7	40	118(126)
32	≤300	301~500	53	18	2	6.5	38	7	40	120(128)
40	≤300	301~500	61	25	2	6.5	46	8	50	138(147)
50	≤300	301~500	76	30	2	9	58	9	58	159(171)
63	≤300	301~500	92	32	2	11	70	9.5	58	159.5(171.5)

Bore size/Item	LT	LX	LZ	M	W	X	Y	Z	ZZ
20	3	32	44	2.8	10	15	7	47	110(118)
25	3	36	49	3.5	10	15	7	52	115.5(123.5)
32	3.5	44	58	3.5	10	16	8	52.5	117.5(125.5)
40	3.5	54	71	4	10	16.5	8.5	63	135(144)
50	4.5	66	86	5	17.5	22	11	75.5	157.5(169.5)
63	4.5	82	106	6	17.5	22	13	75.5	158.5(170.5)

Remark : The values in the “()” are for longer strokes.

Remark : The values in the “()” are for longer strokes.

Mini cylinder

MG Series—Accessories

CB

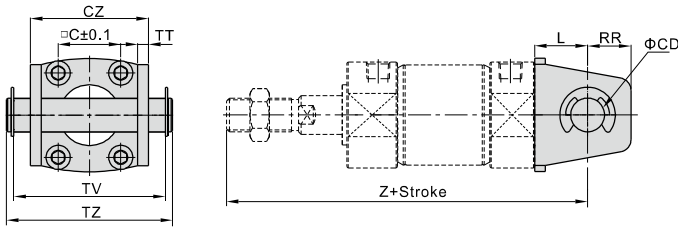

Bore size/Item	Standard stroke	Longer stroke	C	CD	CZ	L	RR	TT	TV	TZ	Z
20	≤200	201~500	14	8	29	14	11	2.5	41	46	118(126)
25	≤300	301~500	16.5	10	33	16	13	2.5	44	50	125(133)
32	≤300	301~500	20	12	40	20	15	3	54	60.5	131(139)
40	≤300	301~500	26	14	49	22	18	3	63	69.5	150(159)
50	≤300	301~500	32	16	60	25	20	4	77	83	173(185)
63	≤300	301~500	38	18	74	30	22	4	95	103	178(190)

Remark : The values in the "()" are for longer strokes.

SDB(+CB)

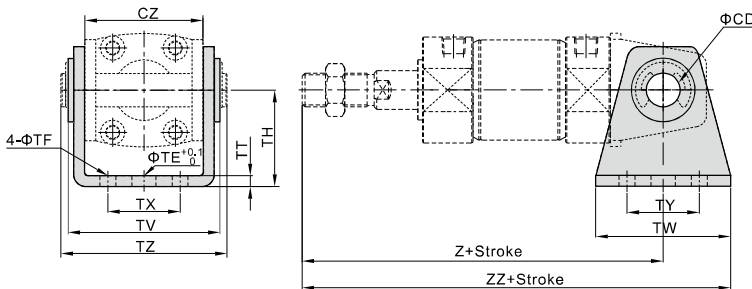

Bore size/Item	Standard stroke	Longer stroke	CD	CZ	TE	TF	TH	TT	TV	TW	TX	TY	TZ	Z	ZZ
20	≤200	201~500	8	29	10	5.5	25	2.5	40.5	42	16	28	46	118(126)	139(147)
25	≤300	301~500	10	33	10	5.5	30	2.5	43.5	42	20	28	50	125(133)	146(154)
32	≤300	301~500	12	40	10	6.5	35	3	53.5	48	22	28	60.5	131(139)	155(163)
40	≤300	301~500	14	49	10	6.5	40	3	62.5	56	30	30	69.5	150(159)	178(187)
50	≤300	301~500	16	60	20	9	50	4	76	64	36	36	83	173(185)	205(217)
63	≤300	301~500	18	74	20	11	60	4	94	74	46	46	103	178(190)	215(227)

Remark : SDB is attached with relevant PIN.
The values in the "()" are for longer strokes.

I Knuckle

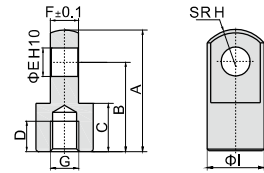

Type/Item	A	B	C	D	E	F	G	H	I
F-ACQ20I	34	25	13.5	8.5	8	7.7	M8×1.25	10.3	16
F-ACQ25I	41	30	16	11	10	9.7	M10×1.25	12.8	20
F-ACQ32I	42	30	16	14	10	17.6	M14×1.5	12	22
F-ACQ50I	56	40	20	18	14	21.6	M18×1.5	16	28

Y Knuckle

F-ACQ20Y, F-ACQ25Y

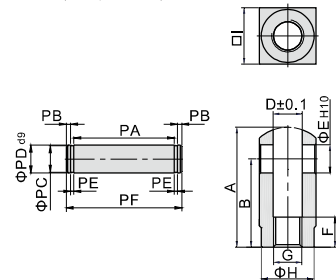

F-ACQ32Y, F-ACQ50Y

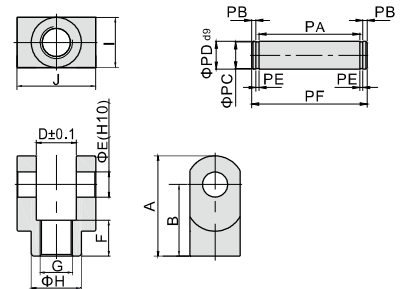

Type/Item	A	B	D	E	F	G
F-ACQ20Y	34	25	8.3	8	8.5	M8×1.25
F-ACQ25Y	41	30	10.3	10	10.5	M10×1.25
F-ACQ32Y	42	30	18.4	10	16	M14×1.5
F-ACQ50Y	56	40	22.4	14	20	M18×1.5

Type/Item	H	I	J	PA	PB	PC	PD	PE	PF
F-ACQ20Y	15	16	-	16.3	1.5	7	8	0.9	21
F-ACQ25Y	19	20	-	20.3	2	8	10	1.1	26.4
F-ACQ32Y	22	22	36	36.3	2	8	10	1.1	42.4
F-ACQ50Y	28	28	44	44.3	2	12	14	1.1	50.4