

DPS Series digital display pressure sensor



Ordering code

DPS N1 □ - 01 020 T

① ② ③ ④ ⑤ ⑥

① Model	② Output type	③ Electrical entry	④ Measurement range	⑤ Lead wire length	⑥ Piping specifications
DPS: Digital Display Pressure Sensor	N1: NPN P1: PNP	Space: Plug-in connector B: Pre-wired type [Note1] D: Bottom plug-in connector	01: -100kPa~100kPa 10: -100kPa~1,000kPa	020: Length 2m 030: Length 3m 050: Length 5m M08:300mm with M8 plug connector[Note2]	T: Male thread NPT1/8; female thread: 10-32UNF

[Note1] The safety grade of pre-wired type is IP63.

[Note2] There is no plug-in connector type for M08.
The sockets of M08 need additional order.
Please check on the below.

Ordering code of Socket

F - EC M08 D 020

① ② ③ ④ ⑤



① Category code	② Type code	③ Socket type	④ Wire type	⑤ Wire length
F: Accessory	EC: Connecting wire	M08:M8 socket	D: 4-wire type	020: 2 meters 030:3meters 050:5meters 100:10meters

User interface Instruction

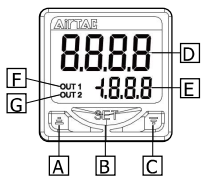

No.	Item
A	Value up button
B	Setting button
C	Value Down button
D	Pressure display area
E	Set pressure display area
F	Output 1 indicator light
G	Output 2 indicator light
H	Power and signal connector
J	Pressure input

Terminal

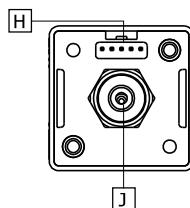

Grommet

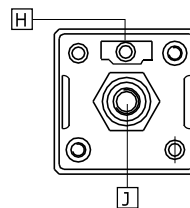

Bottom ported

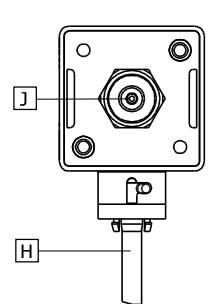

DPS Series digital display pressure sensor

Specification

Input power	Voltage	12~24 VDC ± 10% Ripple(p-p) < 10%
	Fluid	Non-corrosive gas
Pressure range	Measurement range	DPSN1(P1)-01: -100kPa~100kPa
		DPSN1(P1)-10: -100kPa~1,000kPa
	Withstand pressure	DPSN1(P1)-01: 200kPa
		DPSN1(P1)-10: 1500kPa
	Measurement error	± 2% F.S. , ± 1digit(Temperature:25 ± 3°C)
Repetitive accuracy	± 0.2% F.S.	
	Temperature error	± 3% F.S.(Base 25°C, Range 0 to 50°C)
Display	Type	Double row LCD display,4-digit measurement, 3.5-digit setting
	Color	2-color LCD (Red/Green)
	Display period	100ms、250ms、500ms、1,000ms
Output	Output group	DPSN1:Built-in two sets of NPN output DPSP1:Built-in two sets of PNP output
	Transistor output	NPN:Maximum applied voltage 30V/100mA,Retained voltage <1.5V PNP:Maximum applied voltage 30V/100mA,Retained voltage <1.5V
	Output delay time	2ms、20ms、50ms、100ms、250ms、500ms
		1,000ms、2,500ms、5,000ms
	Hysteresis	DPSN1(P1)-01: 0.1、0.2、0.3..... 0.8(kPa) DPSN1(P1)-10: 1、2、3..... 8(kPa)
Pressure Unit	Output mode	Basic mode, Hysteresis mode, Window comparator mode
	DPSN1(P1)-01	kPa, kgf/cm ² , bar, psi, mmHg, inHg
	DPSN1(P1)-10	MPa, kPa, kgf/cm ² , bar, psi, cmHg, inHg
	Vibration resistance	10 to 500Hz with 10mm Amplitude in X, Y, Z directions for 2hrs
	Impact resistance	Maximum 100m/s ² , X, Y, Z directions 3 times each
	Operating Temp. range	0~50°C
	Stored Temp. range	-20~65°C
	Humidity range	35%~80% RH(No condensation)

Dimensions

Plug-in connector

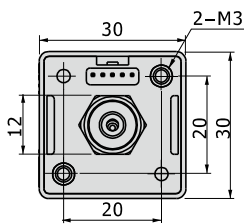

T: Male thread NPT1/8;
female thread: 10-32UNF

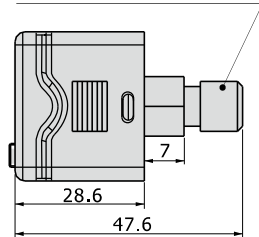

Pre-wired type

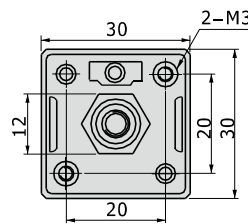

T: Male thread NPT1/8;
female thread: 10-32UNF

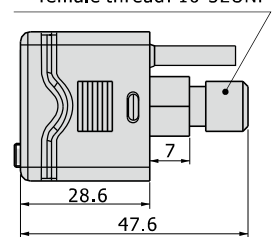

Bottom ported

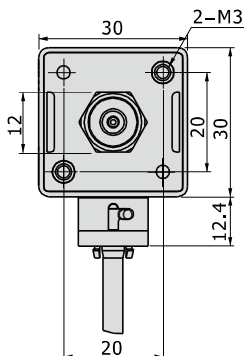

T: Male thread NPT1/8;
female thread: 10-32UNF

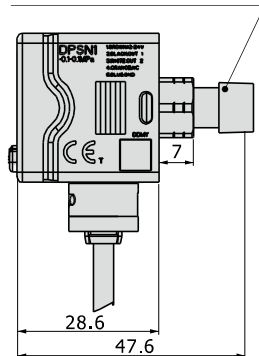

DPS Series digital display pressure sensor

Dimensions/Assembly Instruction

Panel mount adapter + Front protective cover

Order the Installation accessories
(Ordering code:F-DPSEB,applicable to terminal and grommet type)

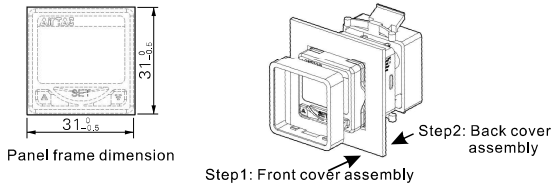

Order the Installation accessories
(Ordering code:F-DPSDEB,applicable to bottom ported type)

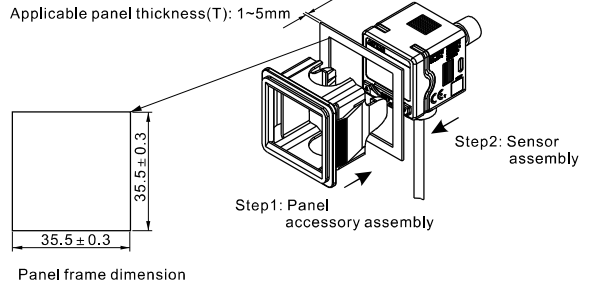

Bracket

Order the installation accessories (Ordering code: F-DPSLB)

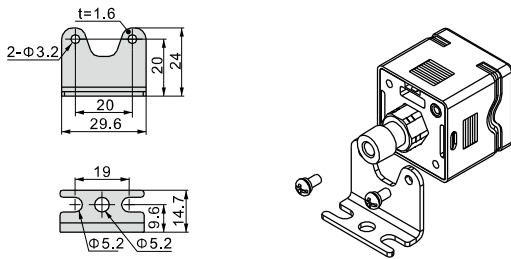

Connection Example

NPN Output

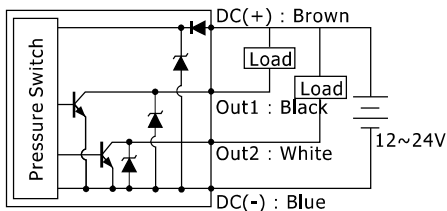

PNP Output

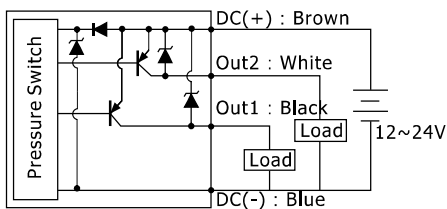

Notes

1. Do not drop · knock or apply excessive impact while handling. Otherwise could cause damage and a malfunction.
2. The tensile strength of the cord is 60N. Applying a greater pulling force on it can cause a malfunction.
3. Do not exceed the screw-in torque of 7N.m when installing piping. Exceeding this value may cause malfunctioning of the sensor.
4. Do not use it with corrosive and/or flammable gases or liquids.
5. Please use it within rated pressure range.
6. Turn off the power before connecting the wires.
7. Don't use in an environment with spattering liquid of oil or solvent.
8. Separate power lines from high voltage lines, avoiding wiring in the same conduit with these lines.
9. When output current exceeds 100mA, circuit protection will be activated. System will resume once reboot.
10. Adjust output-response response time can avoid errors caused by sudden change of working pressure.
11. There is no copy function for PNP type.

DPS Series digital display pressure sensor

User Interface Instructions

1. Mode switch

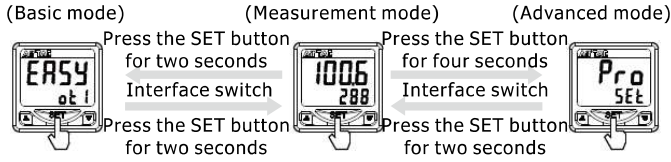

2. Basic mode

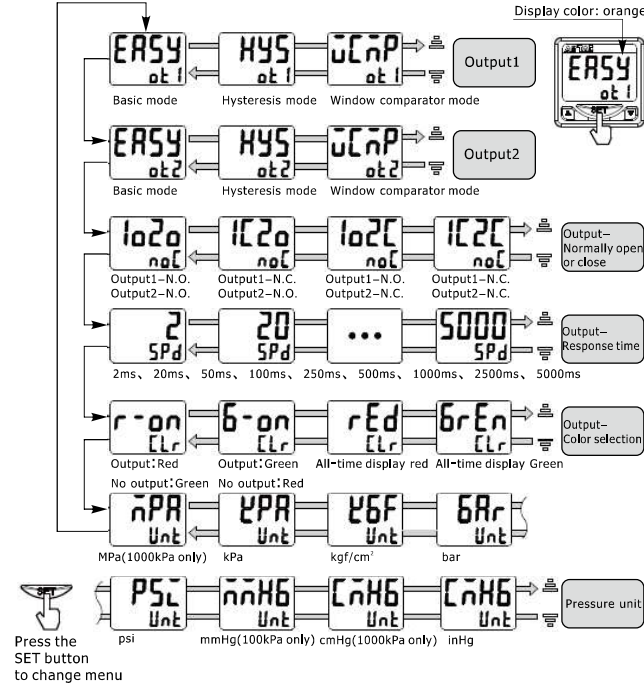

3. Base mode pressure setting

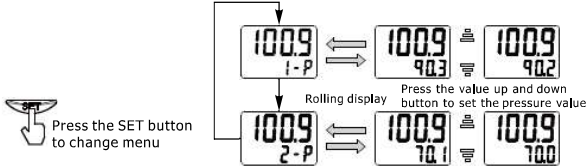

4. Hysteresis /window comparator mode

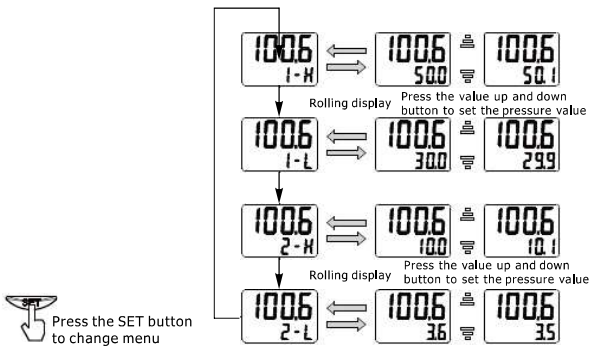

5. Interface of advanced mode

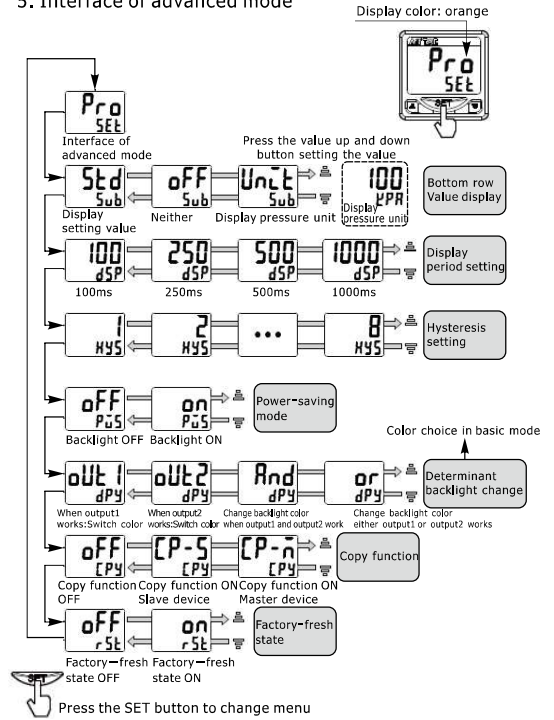

6. Copy function

- Hardware: Connect the second pin of master device with the third pin of slave device, then power on after connecting.
- Software: Set "CP-M" on master device, Set "CP-S" on slave device.
- Icon of copy completed. Repeat step 1 and 2 if copy failed.
- Turn off the power, disconnected devices and restart it after setting.

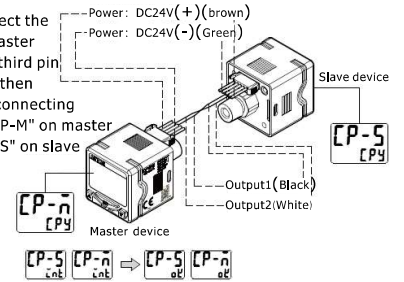

7. Zero-Clear Function

Press up and down simultaneously to reset the display value to zero.

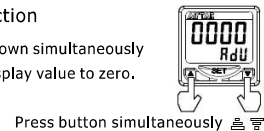

8. Key lock Function

- Press up and the set button simultaneously. Release it when the display turns to "LoCK on".
- Press down and the set button simultaneously. Release it when the display turns to "LoCK off".
- Press any button will display "LCK" in lock on mode.

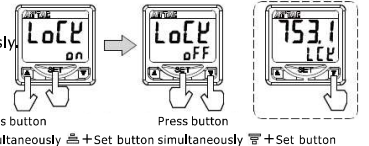

DPS Series digital display pressure sensor

Output mode

1. Basic mode: Air pressure setting value 'P'. When air pressure large then (Setting value P+Hysteresis value), the output is 'NO'; When air pressure less than setting value 'P', the output is 'OFF'.

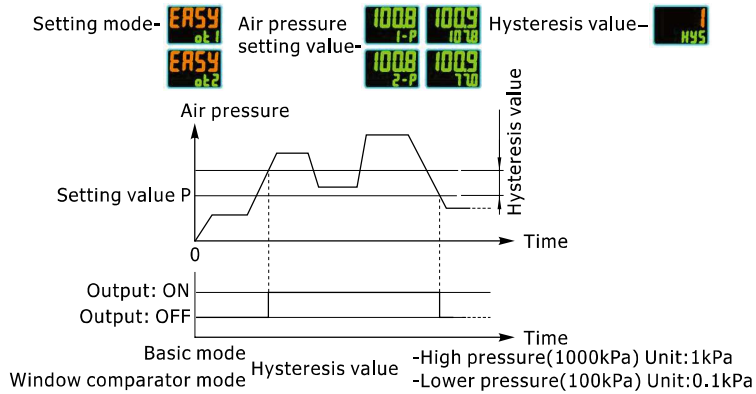

2. Hysteresis mode: Air pressure setting value 'H/L'. When air pressure large then setting value 'H', the output is 'NO'; When air pressure less than setting value 'L', the output is 'OFF'.

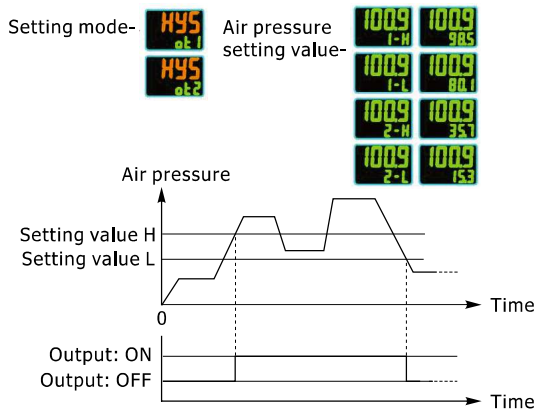

3. Window comparator mode: Air pressure setting value 'H/L'. When air pressure large then value 'H' or less then value 'L', the output is 'OFF'; When air pressure large then value 'L' and less than value 'H', the output is 'ON'.

